



Nothing but **HEAVY DUTY.**





**LDM 45**  
**LDM 100**

- |       |   |           |                                    |
|-------|---|-----------|------------------------------------|
| click | ➔ | <b>EN</b> | Original instructions              |
| click | ➔ | <b>DE</b> | Originalbetriebsanleitung          |
| click | ➔ | <b>FR</b> | Notice originale                   |
| click | ➔ | <b>IT</b> | Istruzioni originali               |
| click | ➔ | <b>ES</b> | Manual original                    |
| click | ➔ | <b>PT</b> | Manual original                    |
| click | ➔ | <b>NL</b> | Oorspronkelijke gebruiksaanwijzing |
| click | ➔ | <b>DA</b> | Original brugsanvisning            |
| click | ➔ | <b>NO</b> | Original bruksanvisning            |
| click | ➔ | <b>SV</b> | Bruksanvisning i original          |

# CONTENTS

Important safety instructions.....1  
 Technical data.....2  
 Specified Conditions of Use .....2  
 Error Code Table .....2  
 Overview.....3  
 Point of Measure .....4  
 Menu.....5  
 Start.....6  
 Length Measuring.....7  
 Surface Area Measuring.....8  
 Total Area Measuring.....9  
 Volume Measuring.....10  
 Indirect Height/Length Measuring (LDM 100 only).....11  
 Indirect Height Measuring (LDM 100 only).....12

# IMPORTANT SAFETY INSTRUCTIONS

  Do not use the product before you have studied the Safety instructions and the User Manual.

## Laser Classification

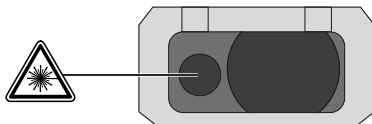

**WARNING:**  
 It is a Class 2 laser product in accordance with EN60825-1:2014 .

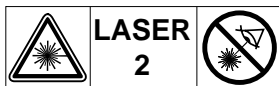

CONSUMER LASER PRODUCT  
 EN 50689:2021

**WARNING:**  
 Avoid direct eye exposure. The laser beam can cause flash blindness.

Do not stare into the laser beam or direct it towards other people unnecessarily.

Don't dazzle other individuals.

**WARNING:**  
 Do not operate the tool around children or allow children to operate the tool.

The reflective surface could reflect the beam back at the operator or other persons.

Keep extremities in a safe distance from the moving parts.

Carry out periodic test measurements. Particularly before, during and after important measurements.

Watch out for erroneous measurements if the product is defective or if it has been dropped or has been misused or modified.

**WARNING:** Use of controls, adjustments, or the performance of procedures other than those specified in the manual may result in hazardous radiation exposure.

The laser distance measurer has limits of use. (Refer to the "Technical data" section). Attempts to measure outside the maximum and minimum range will cause inaccuracy. Use in adverse conditions including too hot, too cold, very bright sunlight, rain, snow, fog, or other vision restricting conditions will result in inaccurate readings.

When the laser distance measurer is brought into a warm environment from very cold conditions, or vice versa, allow it to come to the surrounding temperature before use.

Always store the laser distance measurer indoors, avoid exposing the tool to shock, continuous vibration or extreme temperatures.

Always keep the tool away from dust, liquids and high humidity. These may damage internal components or affect accuracy.

Do not use aggressive cleaning agents or solutions. Use only a clean, soft cloth for cleaning.

Avoid heavy impact to or dropping of the measuring tool. The accuracy of the tool should be checked before use if it has been dropped or subjected to other mechanical stresses.

Any repair required on this laser product should be performed only by authorised service personnel.

Do not operate the product in explosion hazardous areas or in aggressive environments.

 Do not dispose of waste batteries, waste electrical and electronic equipment as unsorted municipal waste. Waste batteries and waste electrical and electronic equipment must be collected separately.

Waste batteries, waste accumulators and light sources have to be removed from equipment.

Check with your local authority or retailer for recycling advice and collection point.

According to local regulations retailers may have an obligation to take back waste batteries and Waste electrical and electronic equipment free of charge.

Your contribution to re-use and recycling of waste batteries and waste electrical and electronic equipment helps to reduce the demand of raw materials.

Waste batteries, in particular containing lithium and waste Electrical and electronic equipment contain valuable, recyclable materials, which can adversely impact the environment and the human health, if not disposed of in an environmentally compatible manner.

Delete personal data from waste equipment, if any.

 European Conformity Mark

 British Conformity Mark

 Ukraine Conformity Mark

 EurAsian Conformity Mark

## TECHNICAL DATA

	LDM 45	LDM 100
Receiving Lens	15 mm x 9 mm	18 mm
Measuring Range		
Minimum distance	0.05 meters	0.05 meters
Maximum distance	45 meters (Tolerance: 45.1 m)	100 meters (Tolerance: 101 m)
Distance Measurement		
Typical tolerance (applies for 100 % target reflectivity (white painted wall), low background illumination, 25 °C)	± 2.0 mm (an additional tolerance of 0.1 mm/m should be taken into account)	± 2.0 mm (an additional tolerance of 0.1 mm/m should be taken into account)
Maximum tolerance (applies to targets with lower reflectivity, high background illumination, or temperatures approaching the lower/upper limit)	± 4.0 mm (an additional tolerance of 0.15 mm/m should be taken into account)	± 4.0 mm (an additional tolerance of 0.15 mm/m should be taken into account)
Smallest unit displayed	1 mm	1 mm
Laser Spot Size		
16 m distance:	25 x 50 mm	25 x 50 mm
Laser Class	2	2
Laser Type	635 nm, < 1 mW	635 nm, < 1 mW
Laser Radiation		
Vertical Angle	± 1 degree	± 1 degree
Horizontal Angle	+ 1 degree	+ 1 degree
Display Type	LCD (31.5 mm x 40 mm)	LCD (31.5 mm x 40 mm)
Laser auto off time	90 sec	90 sec
Device auto off time	180 sec	180 sec
Power Type	AAA 2x (Alkaline Battery)	AAA 2x (Alkaline Battery)
Battery Life	8000 (Single Measure)	8000 (Single Measure)
Tripod mount	1/4" thread	1/4" thread
Operating Temperature Range	0°C to +40°C	0°C to +40°C
Storage Temperature Range	-10°C to +60°C	-10°C to +60°C
Weight without Battery	87 g	122 g
Dust and Water resistance	IP54	IP54

## SPECIFIED CONDITIONS OF USE

The laser distance measurer can be used for measuring distances and tilts.  
Do not use this product in any other way as stated for normal use.

## ERROR CODE TABLE

Code	Description	Solution
Err500	Hardware problems	Turn the meter off and back on. If the problem remains, return the meter to the nearest service center.

# OVERVIEW

## STATUS BAR

- ▶ Reference Point of Measurement, Type of Measurement, Angle (LDM 100 only), Level (LDM 100 only)

## DISPLAY

- ▶ Menu
- ▶ Measurements
- ▶ Settings

## UP / ADD

- ▶ navigate up through menus
- ▶ add value

## MEASURE / OK

- ▶ turn the laser on
- ▶ store measurement
- ▶ select OK in the menu

## MENU

- ▶ History
- ▶ Measurement
- ▶ Settings

## DOWN / SUBTRACT

- ▶ navigate down through menus
- ▶ subtract value

## CLEAR / POWER

- ▶ on / off (press and hold until unit beeps)
- ▶ clear measurement

## POINT OF MEASURE

- ▶ Bottom (standard automatic)
- ▶ Front
- ▶ Corner pin (activates automatically by extending the lever)

## MEASURE

- ▶ turn the laser on
- ▶ store measurement

## CHANGE BATTERIES

Change batteries when battery symbol is flashing.

1

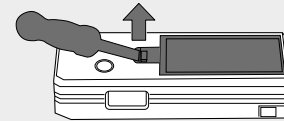

2

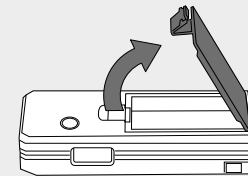

3

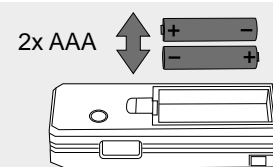

4

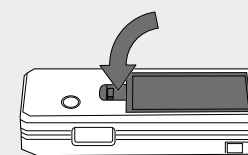

## TRIPOD MOUNT

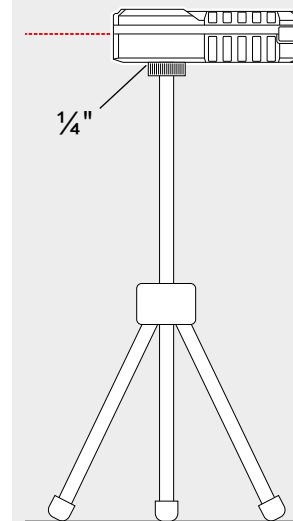

## CORNER PIN

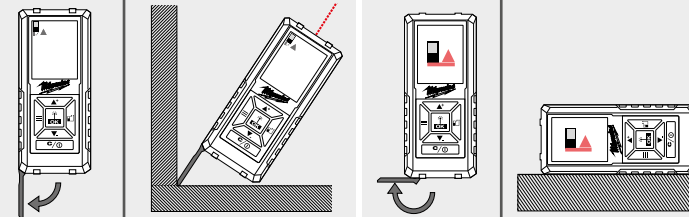

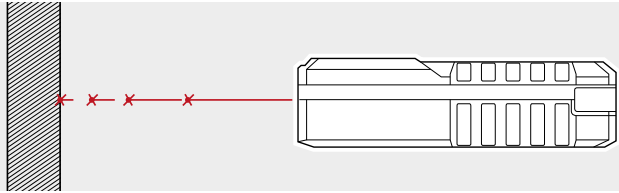

Laser beam flashes continuously.

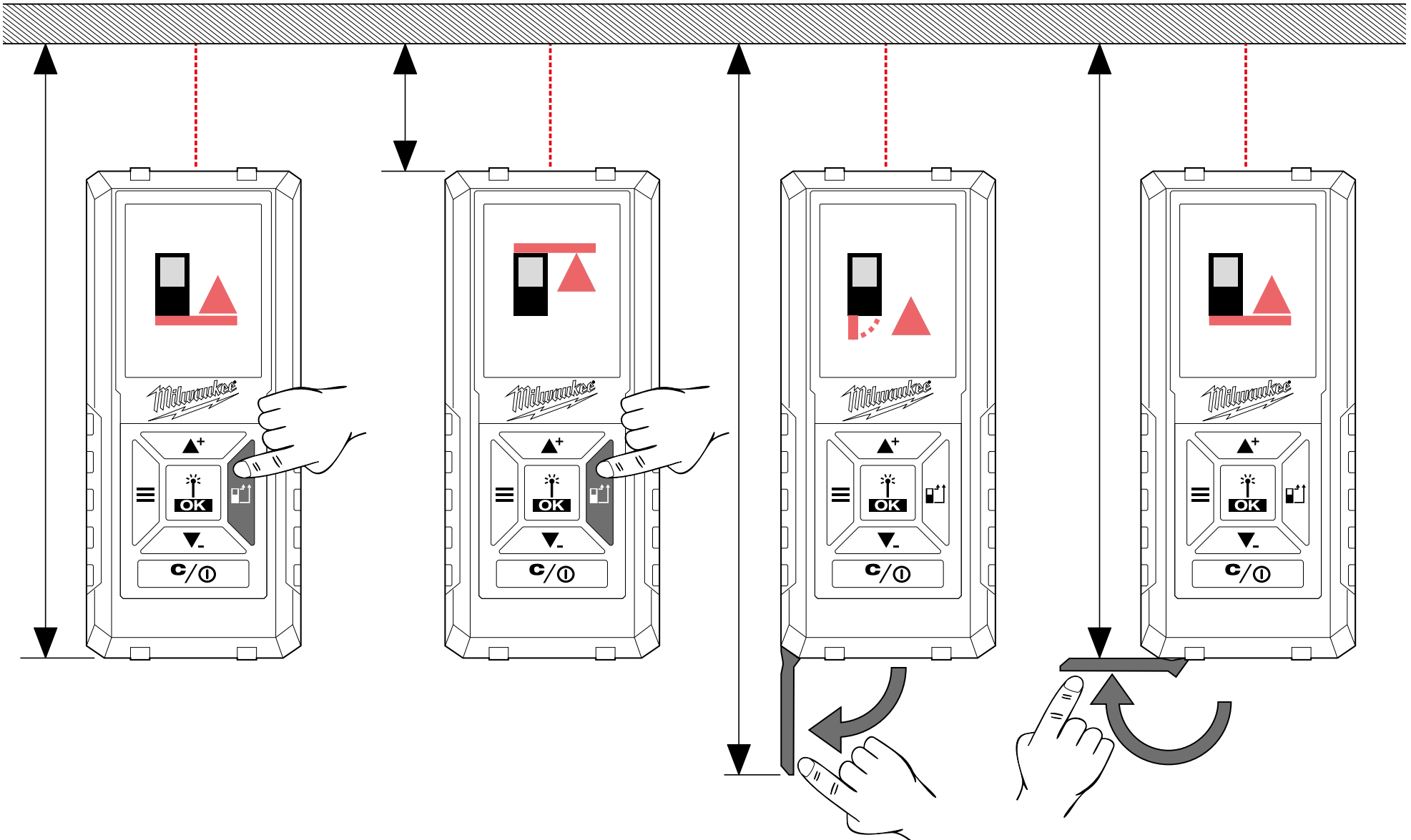

# MENU

## HISTORY

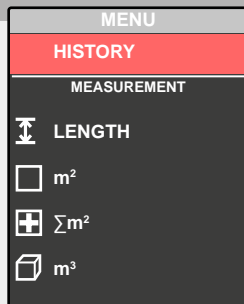

The last 30 measurements/calculations are displayed.

The measurements made to calculate surface area, total area, volume, etc. are not stored in HISTORY. Only the resulting calculation is stored.

To delete an entry press the Clear/Power button.

Additional measurements/calculations can be added or subtracted from entries stored in HISTORY. Only calculations of the same type (length, area, volume, etc.) can be made.

To perform a calculation:

1. Use the ▲+ ▼- buttons to highlight an individual measurement from the HISTORY.
2. Press the OK button.
3. Make the measurement(s) to be used in the calculation.
4. Press the OK button to save the new calculation to HISTORY.

## MEASUREMENT

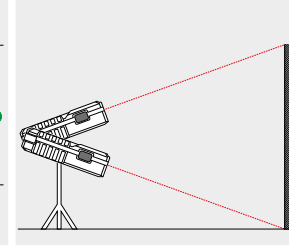
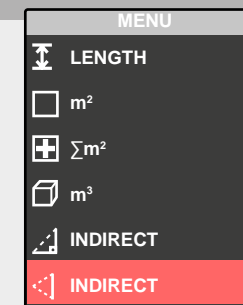
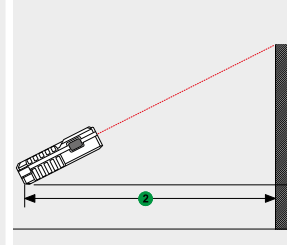
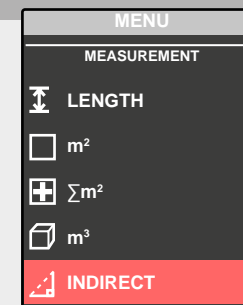
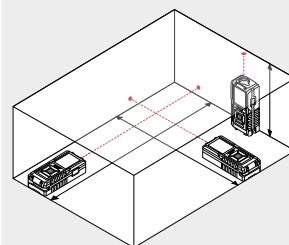
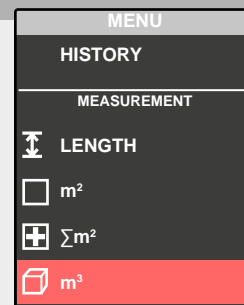
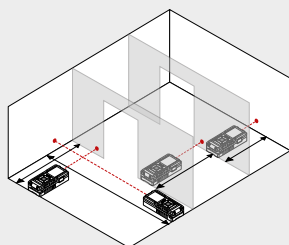
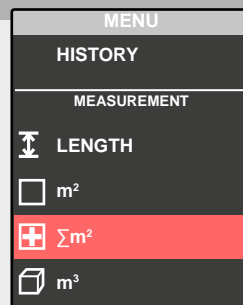
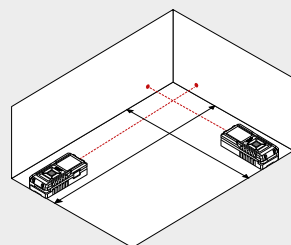
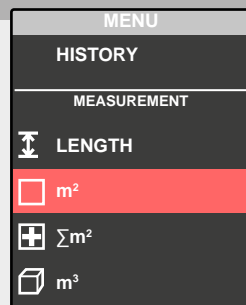
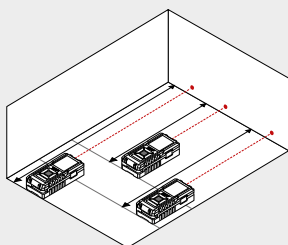
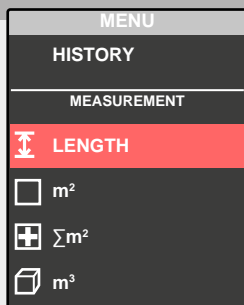

## SETTINGS

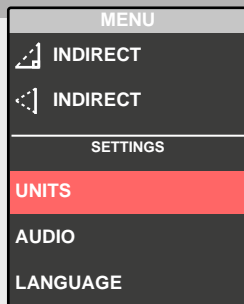

Select desired unit display.

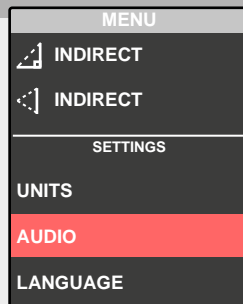

Audio beep on/off.

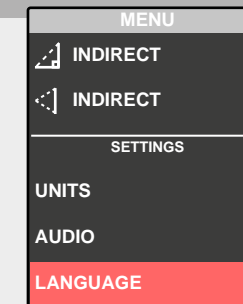

Change language.

START

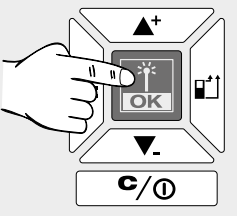
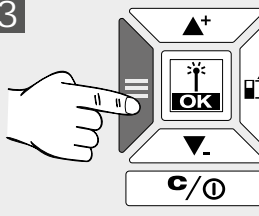
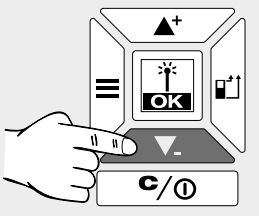
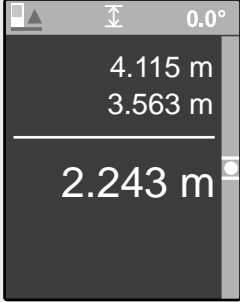
<p>1</p>  <p>1.5 sec</p>	<p>2</p> 	<p>3</p> 	<p>4</p> 	<p>5</p> 
 				
<p>After turning on, the meter goes directly to the LENGTH MEASURE MODE</p>	<p>Make a LENGTH measurement or...</p>	<p>...press the mode button to switch to the Menu...</p>	<p>...and choose another mode by pressing the ▲+ ▼- button...</p>	<p>...and switch to this mode by pressing the OK button.</p>



# LENGTH MEASURING

0



Value white = value is measured

1

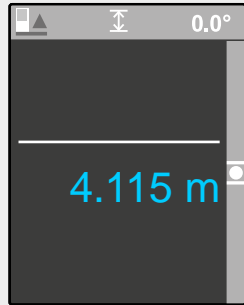
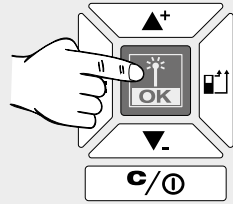

Value blue = value is freezing

2

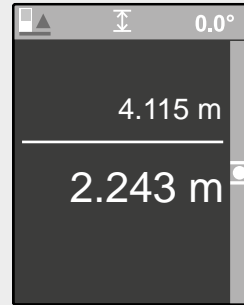
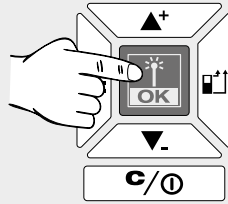

3

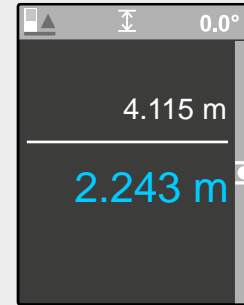
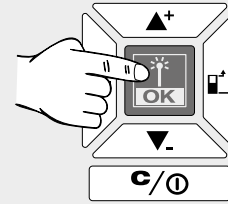

4

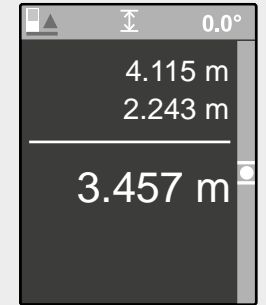
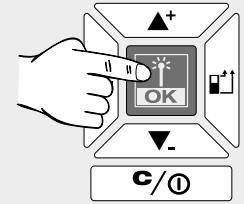

5

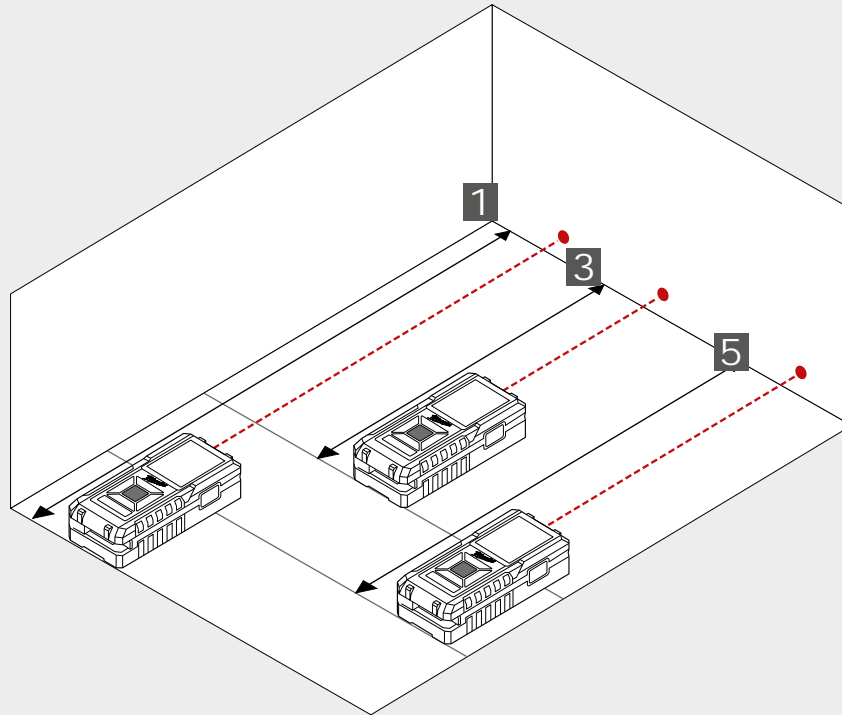
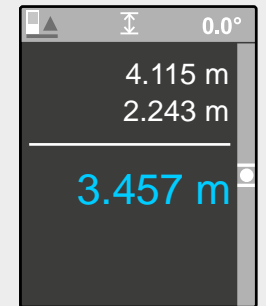
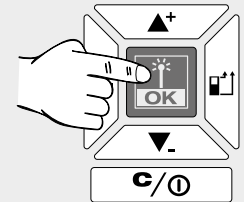



# SURFACE AREA MEASURING

0

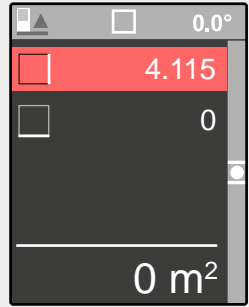

1

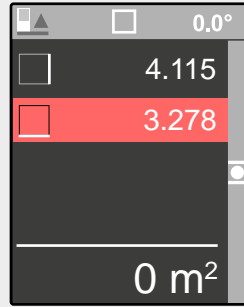
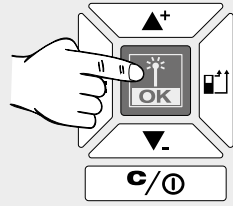

2

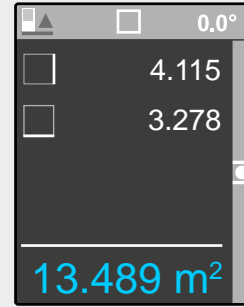
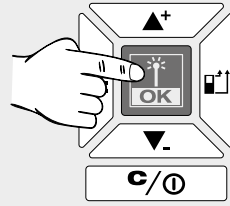

2

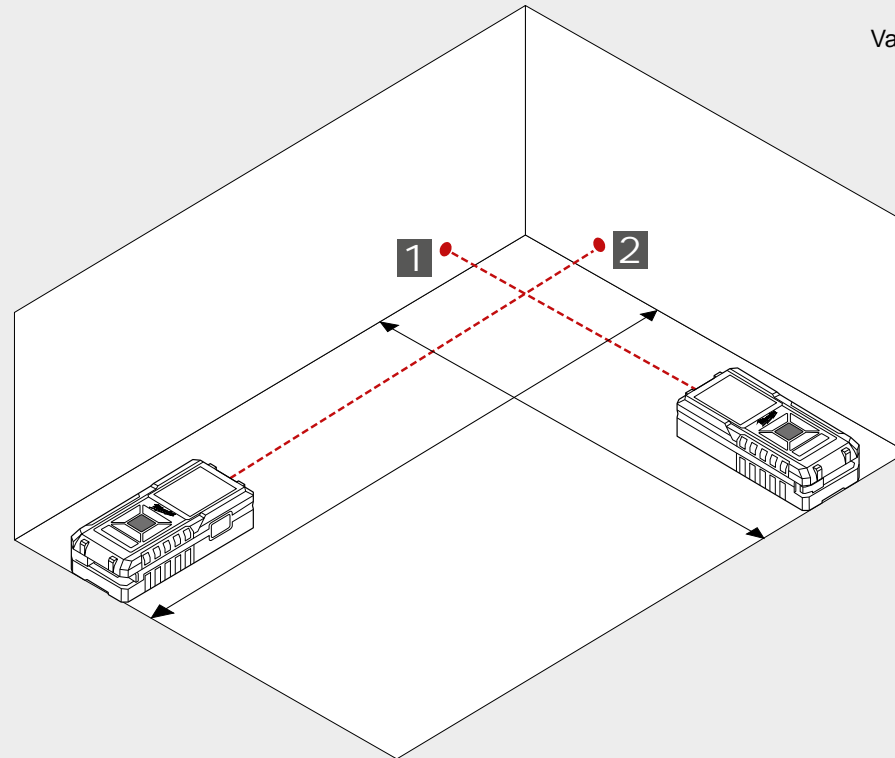
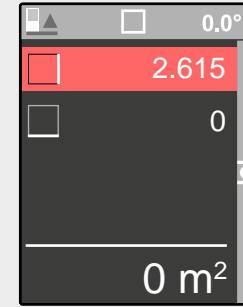
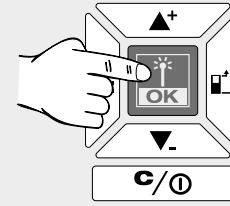

New measurement.  
Value is stored in HISTORY.

# TOTAL AREA MEASURING

0

1

2

3

4

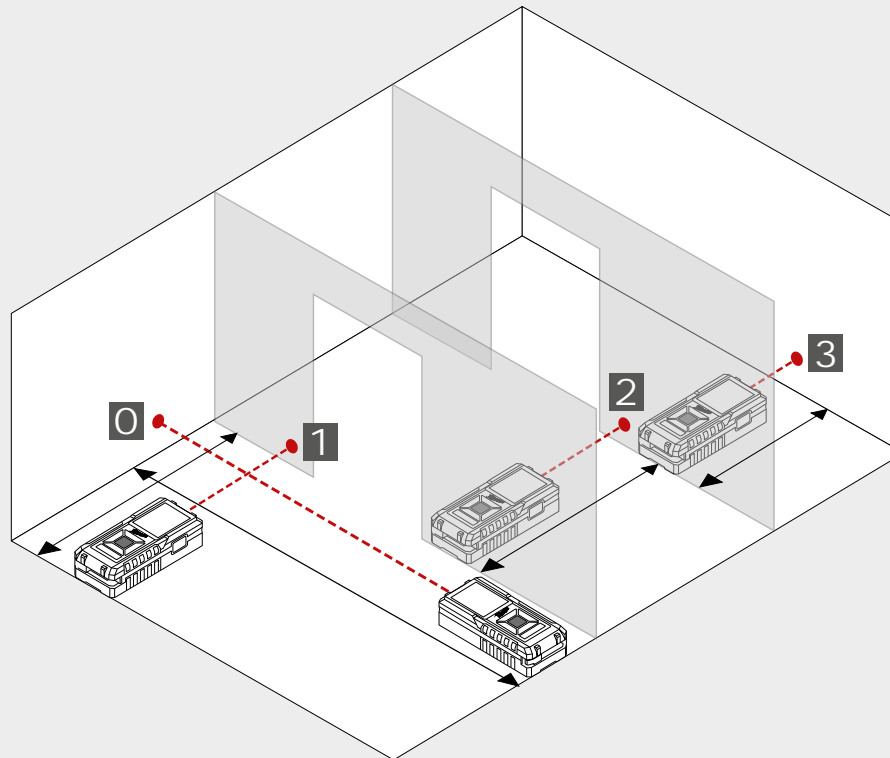
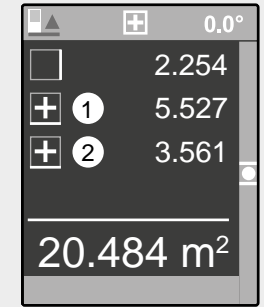
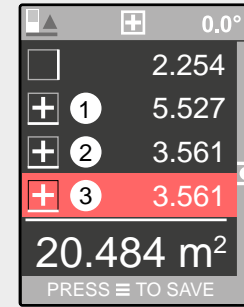
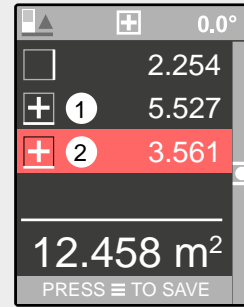
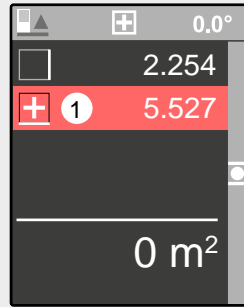
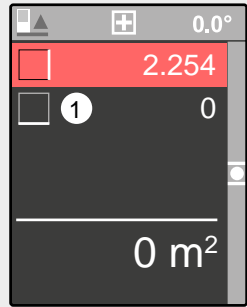
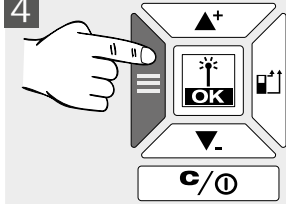
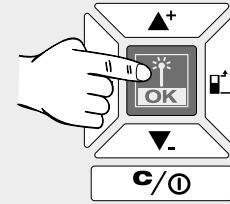
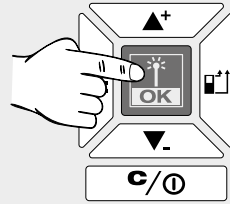
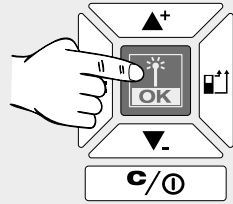

4

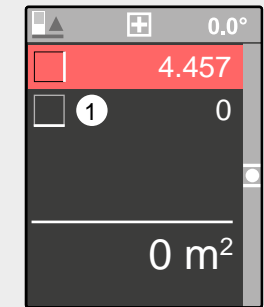
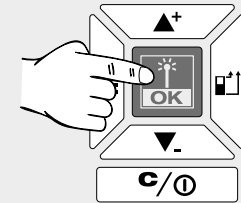

New measurement.  
Result is stored in HISTORY.

# VOLUME MEASURING

0

1

2

3

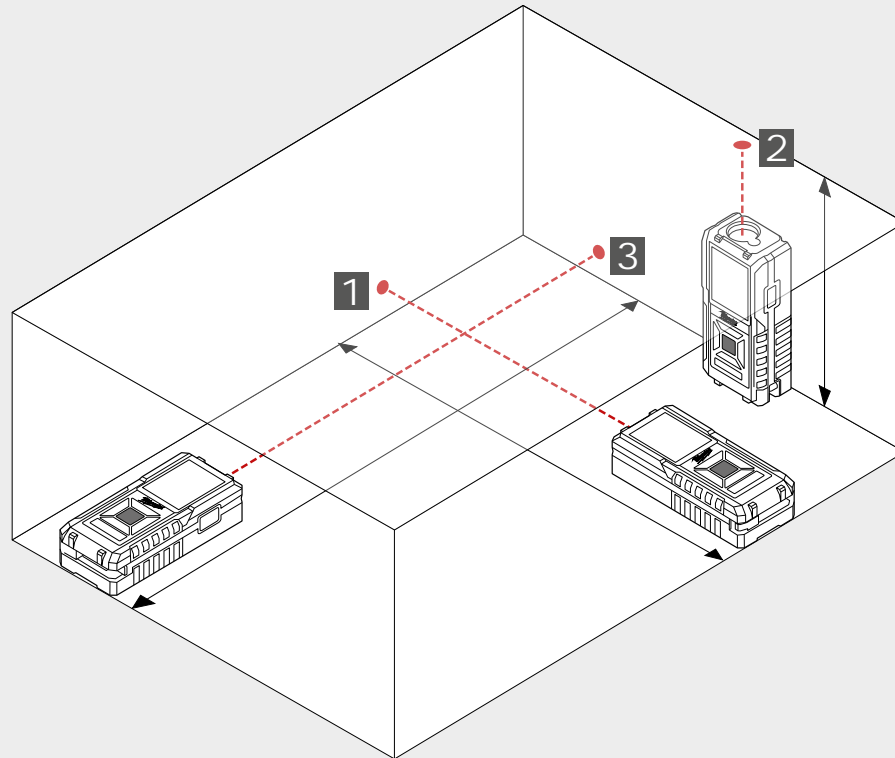
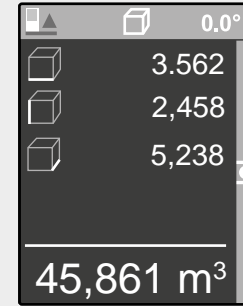
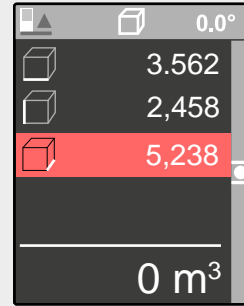
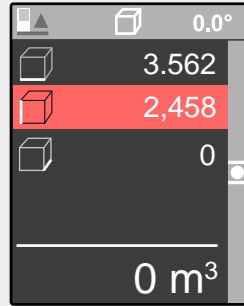
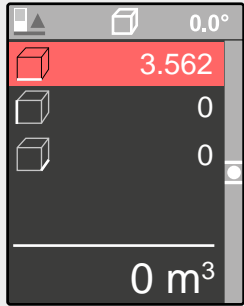
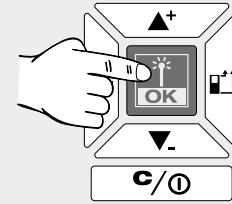
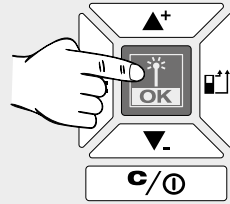
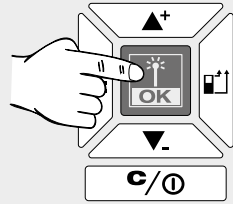

# INDIRECT HEIGHT/LENGTH MEASURING (LDM 100 only)

0

1

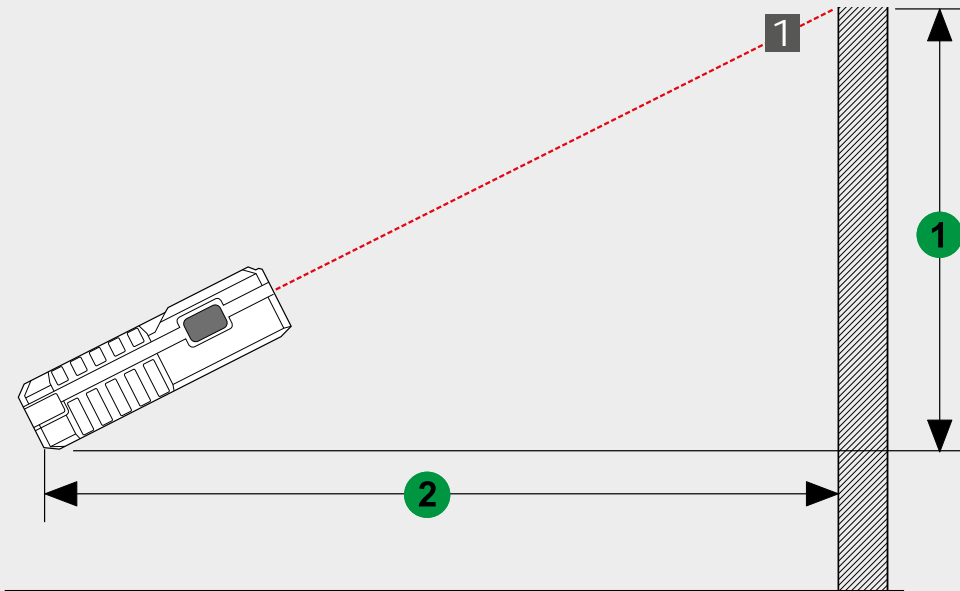
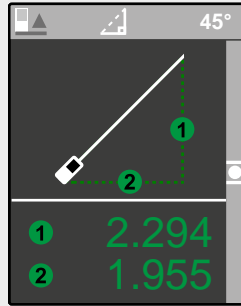
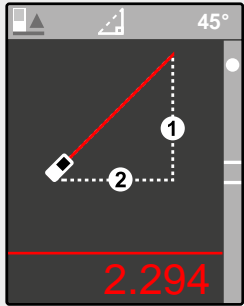
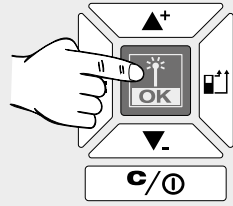

# INDIRECT HEIGHT MEASURING (LDM 100 only)

0

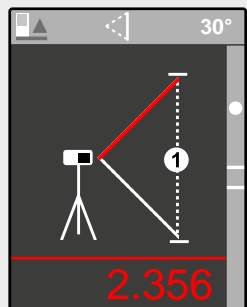

1

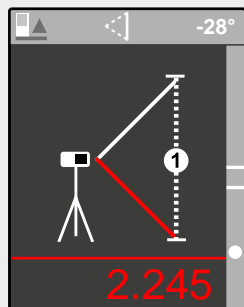
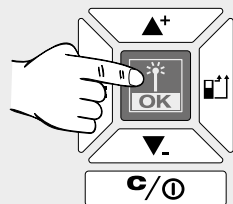

2

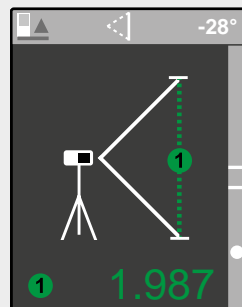
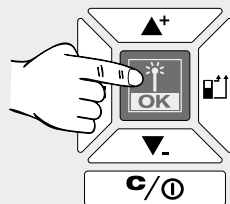

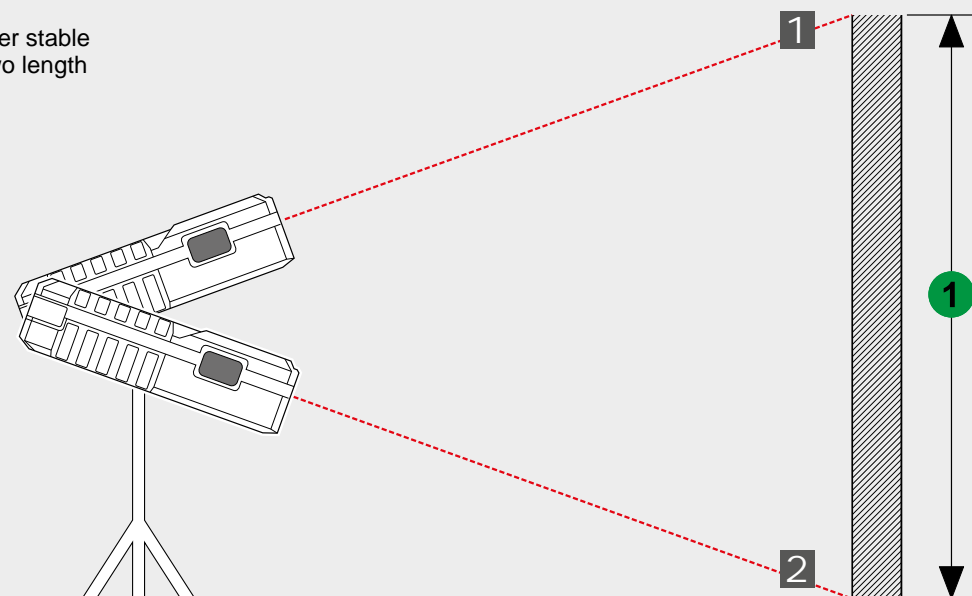

Use a tripod or other stable surface to make two length measurements.



# INHALT

Wichtige Sicherheitshinweise.....1  
 Technische Daten .....2  
 Bestimmungsgemäße Verwendung.....2  
 Fehlercode Tabelle .....2  
 Übersicht .....3  
 Menü.....5  
 Starten .....6  
 Länge messen .....7  
 Fläche messen .....8  
 Gesamtfläche messen.....9  
 Volumen messen .....10  
 Indirekte Höhen-/Längenmessung (nur mit LDM 100) .....11  
 Indirekte Höhenmessung (nur mit LDM 100).....12

# WICHTIGE SICHERHEITSHINWEISE

  Nehmen Sie das Produkt erst in Gebrauch, wenn Sie die Sicherheitshinweise und die Gebrauchsanweisung auf der beiliegenden CD gelesen haben.

## Laserklassifizierung

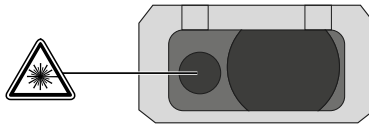

**WARNUNG:**  
 Das Produkt entspricht der Laserklasse 2 gemäss EN60825-1:2014



LASERGERÄT FÜR ENDVERBRAUCHER  
 EN 50689:2021

### Warnung:

Vermeiden Sie direkten Blickkontakt. Der Laserstrahl kann die Augen verblitzen und zu einer kurzzeitigen Blendung führen. Nicht in den Laserstrahl blicken und Strahl nicht unnötigerweise auf andere Personen richten. Keine anderen Personen blenden.

### Warnung:

Das Laser-Gerät nicht in der Nähe von Kindern betreiben oder Kindern erlauben, das Laser-Gerät zu benutzen. Achtung! Eine reflektierende Oberfläche könnte den Laserstrahl zurück an den Bediener oder andere Personen reflektieren. Halten Sie einen entsprechenden Sicherheitsabstand zu den beweglichen Teilen. Regelmässige Kontrollmessungen durchführen, insbesondere vor, während und nach wichtigen Messaufgaben. Vorsicht vor fehlerhaften Messungen beim Verwenden eines defekten Produkts, nach einem Sturz oder sonstigen unzulässigen Anwendungen bzw. Veränderungen am Produkt. **Warnung:** Die Verwendung von Steuerelementen, Einstellungen oder die Durchführung von anderen als den im Handbuch festgelegten Verfahren kann zu gefährlicher Strahlenbelastung führen.

Das Lasermessgerät hat einen begrenzten Einsatzbereich. (Siehe Abschnitt "Technische Daten"). Versuche, außerhalb des maximalen und minimalen Bereichs zu messen, verursachen Ungenauigkeiten. Der Einsatz bei widrigen Bedingungen, wie zu heiß, zu kalt, sehr hellem Sonnenlicht, Regen, Schnee, Nebel oder

anderen sichteinschränkenden Bedingungen, kann zu ungenauen Messungen führen.

Wenn das Lasermessgerät von einer warmen Umgebung in eine kalte Umgebung gebracht wird (oder umgekehrt), warten Sie, bis sich das Gerät der neuen Umgebungstemperatur angepasst hat.

Das Lasermessgerät immer innerhalb von Räumen aufbewahren, das Gerät vor Erschütterung, Vibrationen oder extremen Temperaturen schützen.



Das Lasermessgerät vor Staub, Nässe und hoher Luftfeuchtigkeit schützen. Dies kann innere Bauteile zerstören oder die Genauigkeit beeinflussen.

Verwenden Sie keine aggressiven Reinigungsmittel oder Lösungsmittel. Nur mit einem sauberen, weichen Tuch reinigen.

Vermeiden Sie starke Schläge auf das oder den Fall des Lasermessgeräts. Die Genauigkeit des Gerätes sollte überprüft werden, wenn es heruntergefallen ist oder anderen mechanischen Belastungen ausgesetzt war.

Erforderlichen Reparaturen an diesem Laser-Gerät dürfen nur von autorisiertem Fachpersonal durchgeführt werden.

Das Produkt darf nicht in einer explosionsgefährdeten oder aggressiven Umgebung eingesetzt werden.

 Altbatterien, Elektro- und Elektronik-Altgeräte dürfen nicht zusammen mit dem Hausmüll entsorgt werden.  Altbatterien, Elektro- und Elektronik-Altgeräte sind getrennt zu sammeln und zu entsorgen.

Entfernen Sie Altbatterien, Altkumulatoren und Leuchtmittel vor dem Entsorgen aus den Geräten. Erkundigen Sie sich bei den örtlichen Behörden oder bei Ihrem Fachhändler nach Recyclinghöfen und Sammelstellen. Je nach den örtlichen Bestimmungen können Einzelhändler verpflichtet sein, Altbatterien, Elektro- und Elektronik-Altgeräte kostenlos zurückzunehmen. Tragen Sie durch Wiederverwendung und Recycling Ihrer Altbatterien, Elektro- und Elektronik-Altgeräte dazu bei, den Bedarf an Rohmaterialien zu verringern. Altbatterien (vor allem Lithium-Ionen-Batterien), Elektro- und Elektronik-Altgeräte enthalten wertvolle, wiederverwertbare Materialien, die bei nicht umweltgerechter Entsorgung negative Auswirkungen auf die Umwelt und Ihre Gesundheit haben können. Löschen Sie vor der Entsorgung möglicherweise auf Ihrem Altgerät vorhandene personenbezogene Daten.

 Europäisches Konformitätszeichen

 Britisches Konformitätszeichen

 Ukrainisches Konformitätszeichen

 Euroasiatisches Konformitätszeichen



## TECHNISCHE DATEN

	LDM 45	LDM 100
Optik	15 mm x 9 mm	18 mm
Messbereich		
Minimaler Abstand	0,05 m	0,05 m
Maximaler Abstand	45 m (Toleranz: 45,1 m)	100 m (Toleranz: 101 m)
Abstandsmessung		
Typische Toleranz (gilt für 100 % Zielreflexion (weiß lackierte Wand), geringe Hintergrundbeleuchtung, 25 °C)	± 2,0 mm (eine zusätzliche Toleranz von 0,1 mm/m sollte berücksichtigt werden)	± 2,0 mm (eine zusätzliche Toleranz von 0,1 mm/m sollte berücksichtigt werden)
Maximale Toleranz (gilt für Ziele mit geringerer Reflexion, hoher Hintergrundbeleuchtung oder Temperaturen, die sich dem unteren/oberen Wert nähern)	± 4,0 mm (eine zusätzliche Toleranz von 0,15 mm/m sollte berücksichtigt werden)	± 4,0 mm (eine zusätzliche Toleranz von 0,15 mm/m sollte berücksichtigt werden)
Kleinste anzeigbare Einheit	1,0 mm	1,0 mm
Laserpunktgröße		
16 m Entfernung:	25 x 50 mm	25 x 50 mm
Laserklasse	2	2
Lasertyp	635 nm, < 1 mW	635 nm, < 1 mW
Laserstrahl		
Vertikalwinkel	+1 Grad	+1 Grad
Horizontalwinkel	±1 Grad	±1 Grad
Display Typ	LCD (31,5 mm x 40 mm)	LCD (31,5 mm x 40 mm)
Automatische Laserabschaltung	90 Sekunden	90 Sekunden
Automatische Geräteabschaltung	180 Sekunden	180 Sekunden
Stromversorgung	AAA 2x (Alkaline-Batterie)	AAA 2x (Alkaline-Batterie)
Batterielebensdauer	8000 (Einzelmessung)	8000 (Einzelmessung)
Stativgewinde	1/4"	1/4"
Arbeitstemperaturbereich	-0°C bis +40°C	-0°C bis +40°C
Lagertemperaturbereich	-10°C bis +60°C	-10°C bis +60°C
Gewicht ohne Batterie	87 g	122 g
Schutzklasse	IP54 (staub- und spritzwassergeschützt)	IP54 (staub- und spritzwassergeschützt)
Dust and Water resistance	IP54	IP54

## BESTIMMUNGSGEMÄSSE VERWENDUNG

Das Lasermessgerät ist geeignet zum Messen von Distanzen und Neigungen.  
Dieses Gerät darf nur wie angegeben bestimmungsgemäß verwendet werden.

## FEHLERCODE TABELLE

Code	Beschreibung	Lösung
Err500	Hardwareprobleme	Schalten Sie das Messgerät aus und wieder ein. Bleibt das Problem bestehen, bringen Sie das Messgerät zur nächsten Servicezentrale.

# ÜBERSICHT

## STATUSLEISTE

- ▶ Referenzmesspunkt, Art der Messung, Messwinkel (nur mit LDM 100), Messebene (nur mit LDM 100)

## DISPLAY

- ▶ Menü
- ▶ Messungen
- ▶ Einstellungen

## NACH OBEN / ADDIEREN

- ▶ Im Menü nach oben gehen
- ▶ Wert addieren

## MESSUNG / OK

- ▶ Laser einschalten
- ▶ Messwert speichern
- ▶ OK im Menü auswählen

## MENÜ

- ▶ Verlauf
- ▶ Messung
- ▶ Einstellungen

## NACH UNTEN / SUBTRAHIEREN

- ▶ Im Menü nach unten gehen
- ▶ Wert subtrahieren

## LÖSCHEN / EIN-/AUSSCHALTEN

- ▶ EIN / AUS (Taste gedrückt halten, bis das Gerät einen Signalton ausgibt)
- ▶ Messwert löschen

## MESSPUNKT

- ▶ Hinten (Standardeinstellung)
- ▶ Vorne
- ▶ Ecke (wird automatisch durch Ausklappen des Stifts aktiviert)



## MESSEN

- ▶ Laser einschalten
- ▶ Messwert speichern

## BATTERIEN WECHSELN

- ▶ Batterien wechseln, wenn das Batteriesymbol blinkt.

1

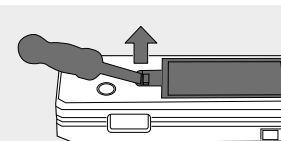

2

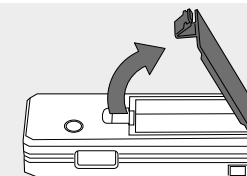

3

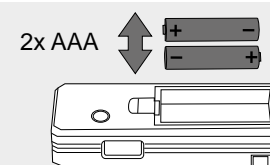

4

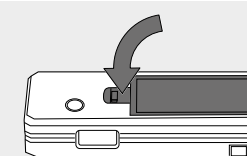

## STATIV

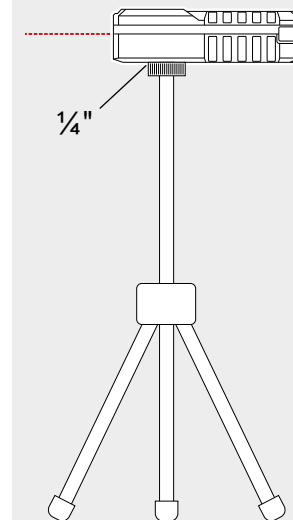

## ECKSTIFT

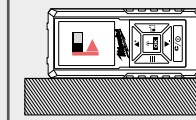
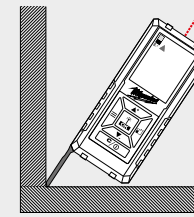



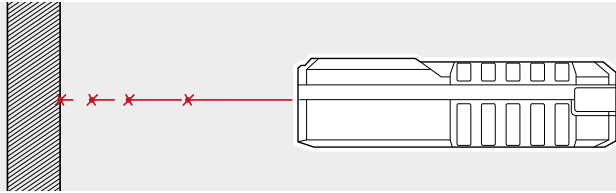

Der Laserstrahl blinkt kontinuierlich während der Messung.

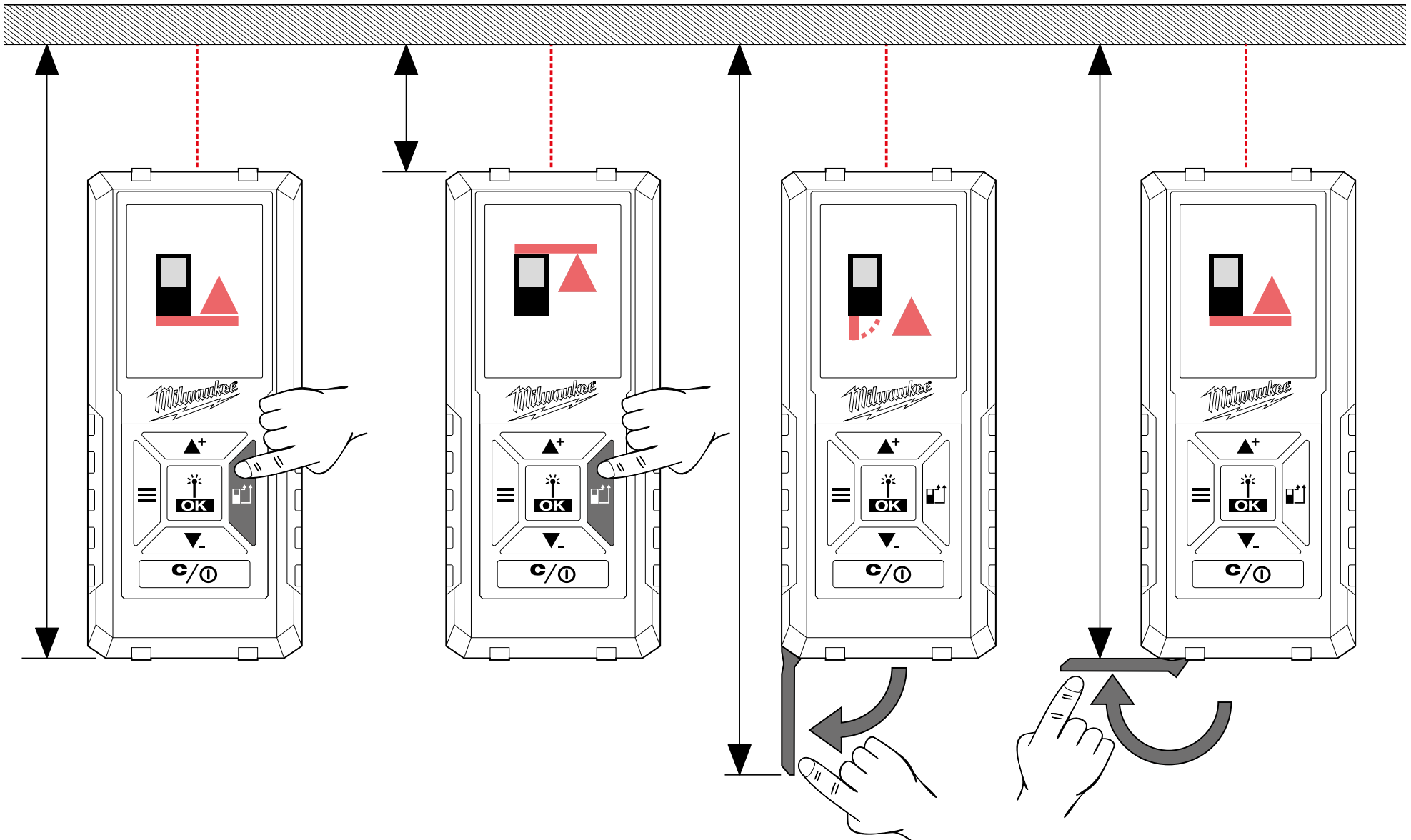

VERLAUF



Anzeige der letzten 30 Messungen/  
Berechnungen.

Die Einzelmessungen zur Berechnung von  
Oberfläche, Gesamtfläche, Volumen etc.  
werden nicht unter VERLAUF gespeichert,  
sondern nur das Ergebnis der Berechnungen.

Um einen Eintrag zu löschen, die Taste C/EIN/  
AUS drücken.

Zu den unter VERLAUF gespeicherten Werten  
können Messungen/Berechnungen addiert  
oder von ihnen subtrahiert werden. Es können  
nur Berechnungen derselben Art ausgeführt  
werden (Länge, Fläche, Volumen etc.).

Durchführen einer Berechnung:

1. Die Tasten ▲+ ▼- verwenden, um einen  
Messmodus aus dem VERLAUF  
auszuwählen.
2. Die OK-Taste drücken.
3. Die zur Berechnung erforderlichen  
Messungen durchführen.
4. Die Taste OK drücken, um die neue  
Berechnung im VERLAUF zu speichern.

MESSUNG

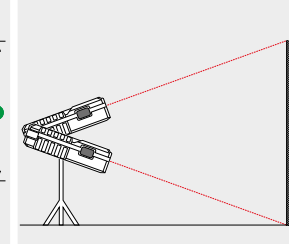
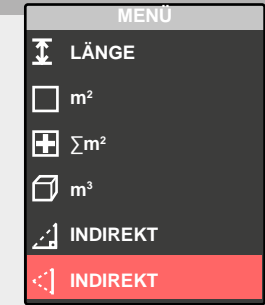
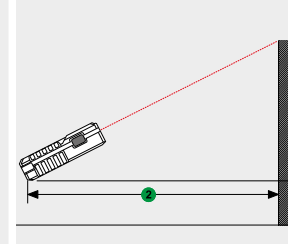
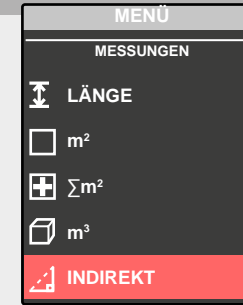
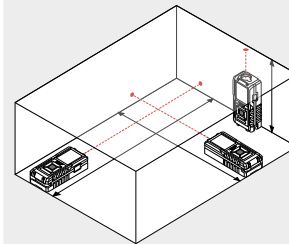
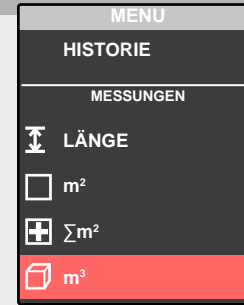
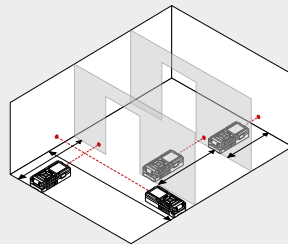
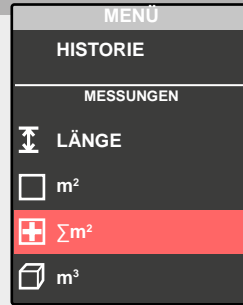
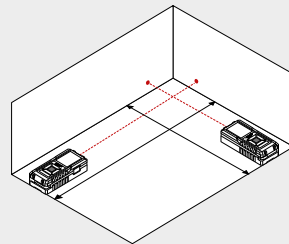
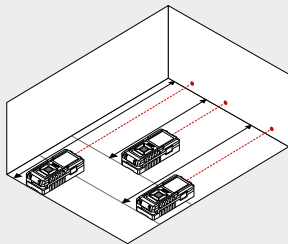
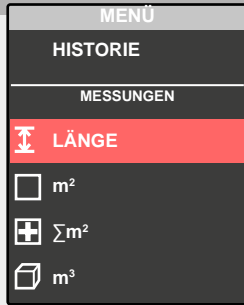

EINSTELLUNGEN

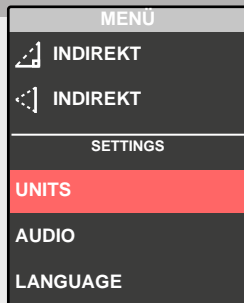



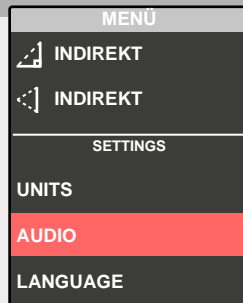

Die gewünschte  
Maßeinheit wählen.

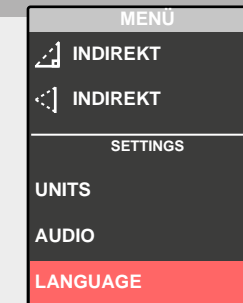

Signalton an/aus.

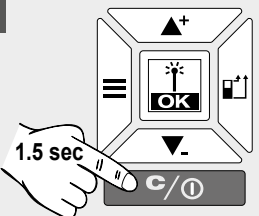
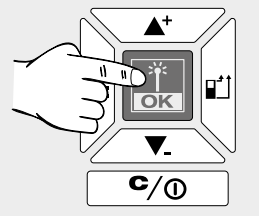
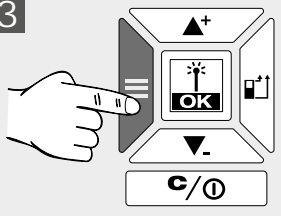
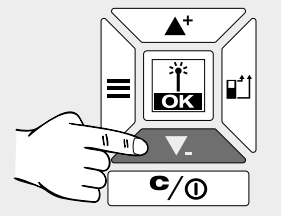
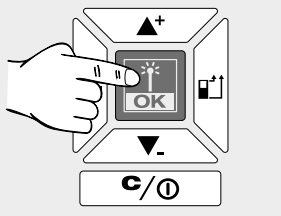

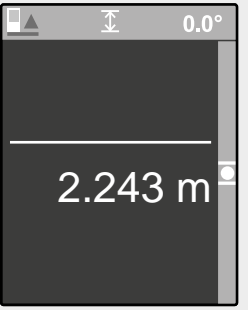
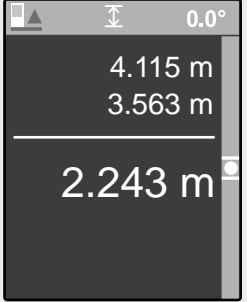
Sprache wählen.

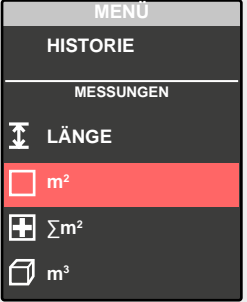
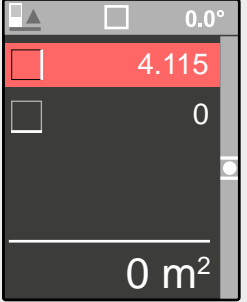
<p>1</p> 	<p>2</p> 	<p>3</p> 	<p>4</p> 	<p>5</p> 
 				
<p>Nach dem Einschalten wird automatisch der LÄNGENMESSMODUS aktiviert.</p>	<p>Führen Sie eine LÄNGENMESSUNG durch oder ...</p>	<p>... drücken Sie die Menütaste, um zum Menü zu wechseln ...</p>	<p>... und wählen Sie eine andere Betriebsart mit Hilfe der Tasten ▲+ ▼- und ...</p>	<p>... und aktivieren Sie diese Betriebsart durch Drücken der Taste OK.</p>

# LÄNGE MESSEN

0



Messwert weiß = Wert gemessen

1

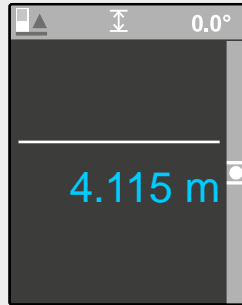
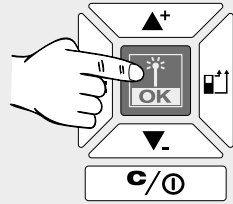

Messwert blau = Wert zwischengespeichert

2

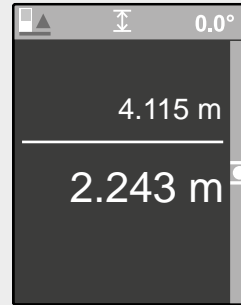
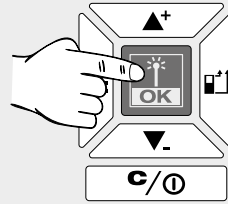

3

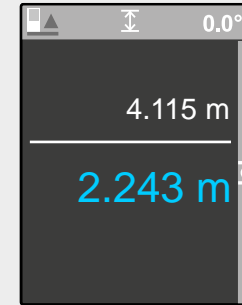
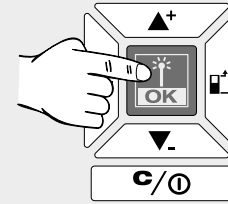

4

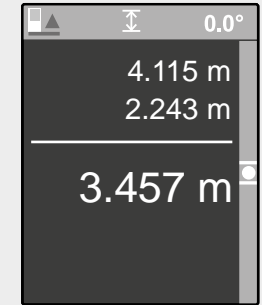
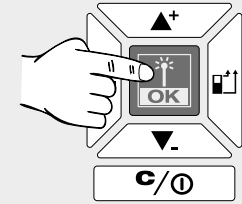

5

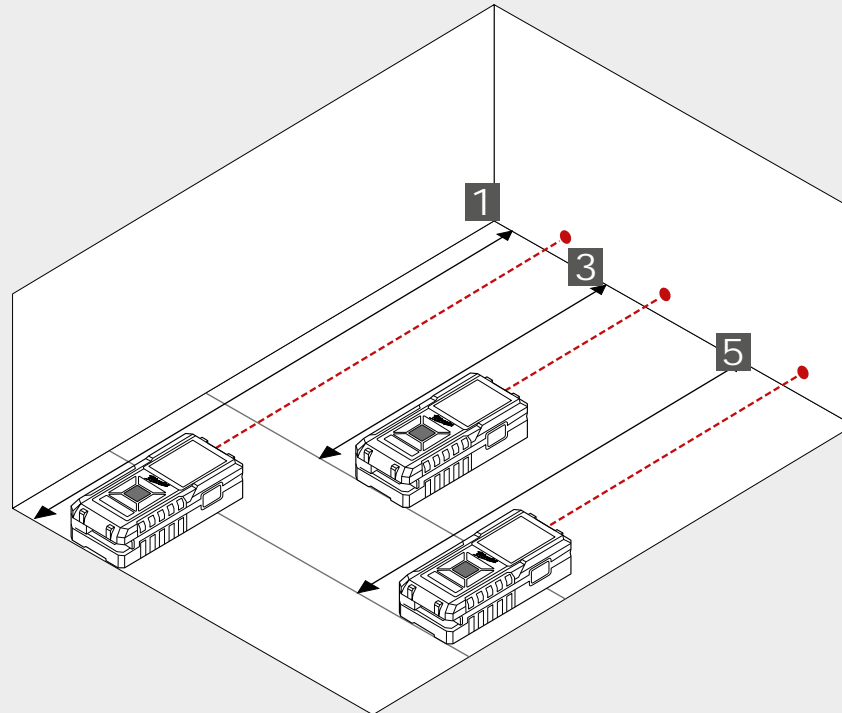
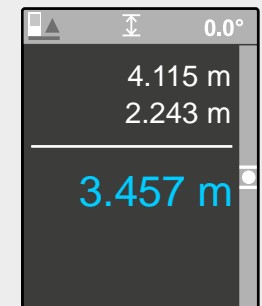
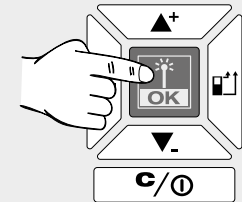

0

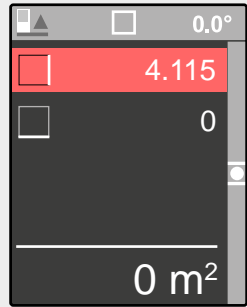

1

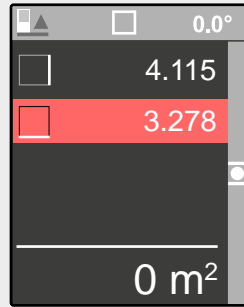
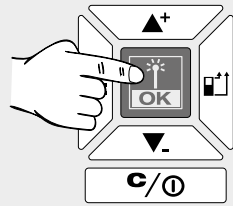

2

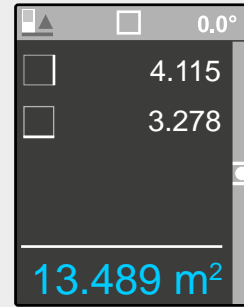
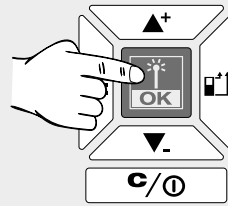

2

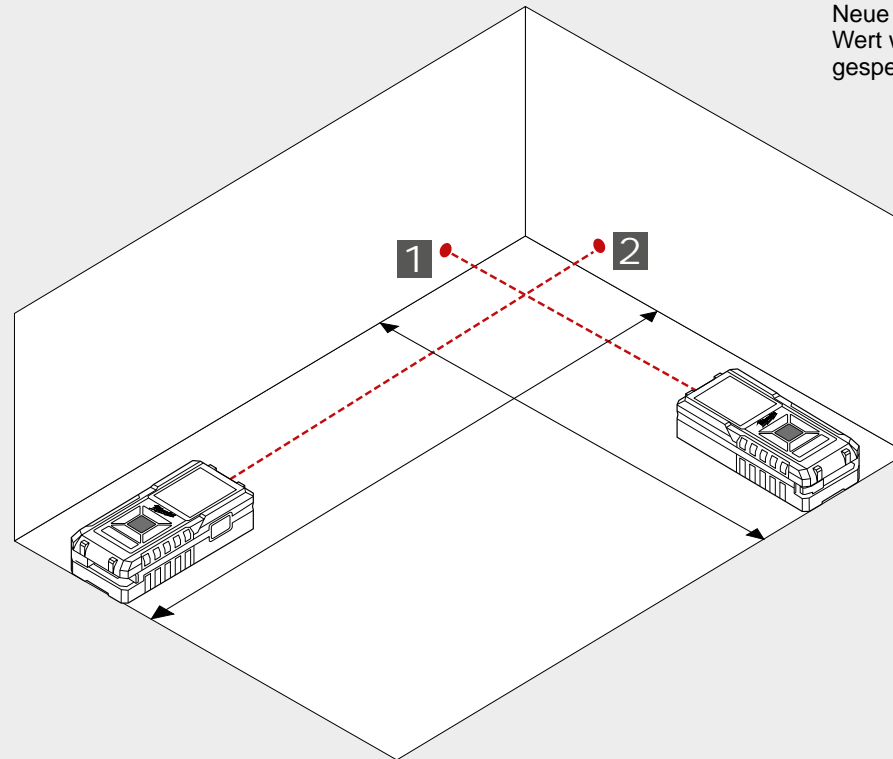
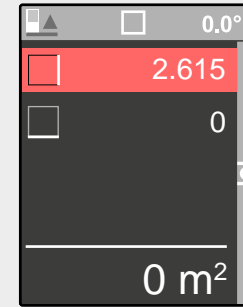
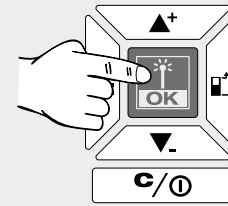

Neue Messung.  
Wert wird unter VERLAUF  
gespeichert.

# GESAMTFLÄCHE MESSEN

0

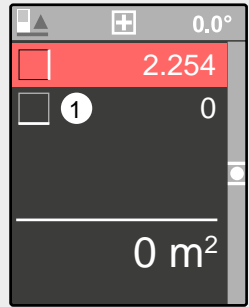

1

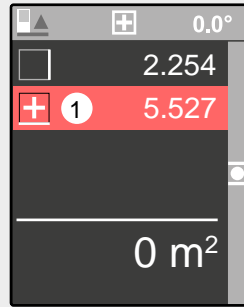
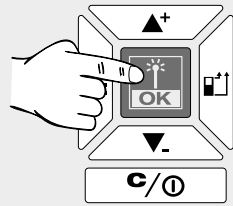

2

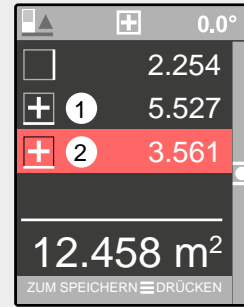
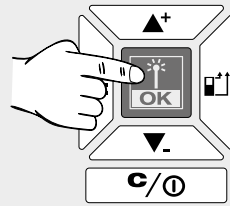

3

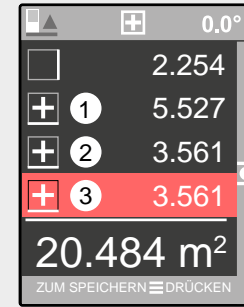
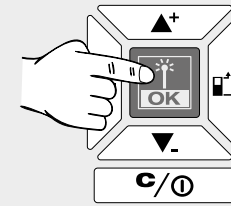

4

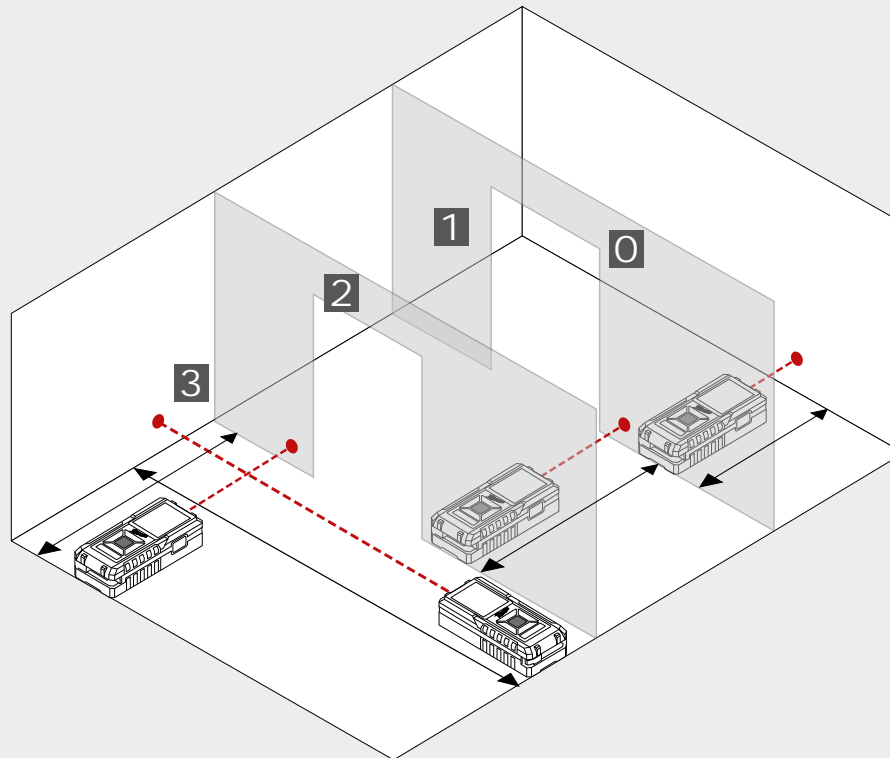
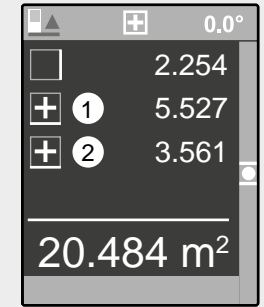
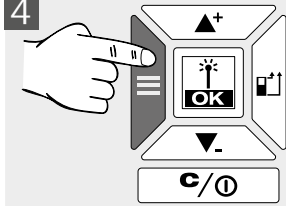

4

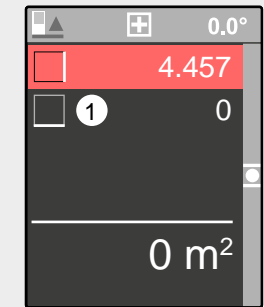
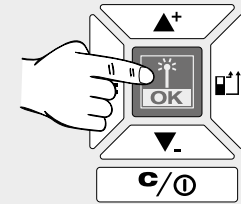

Neue Messung.  
Ergebnis wird unter VERLAUF  
gespeichert.

0

1

2

3

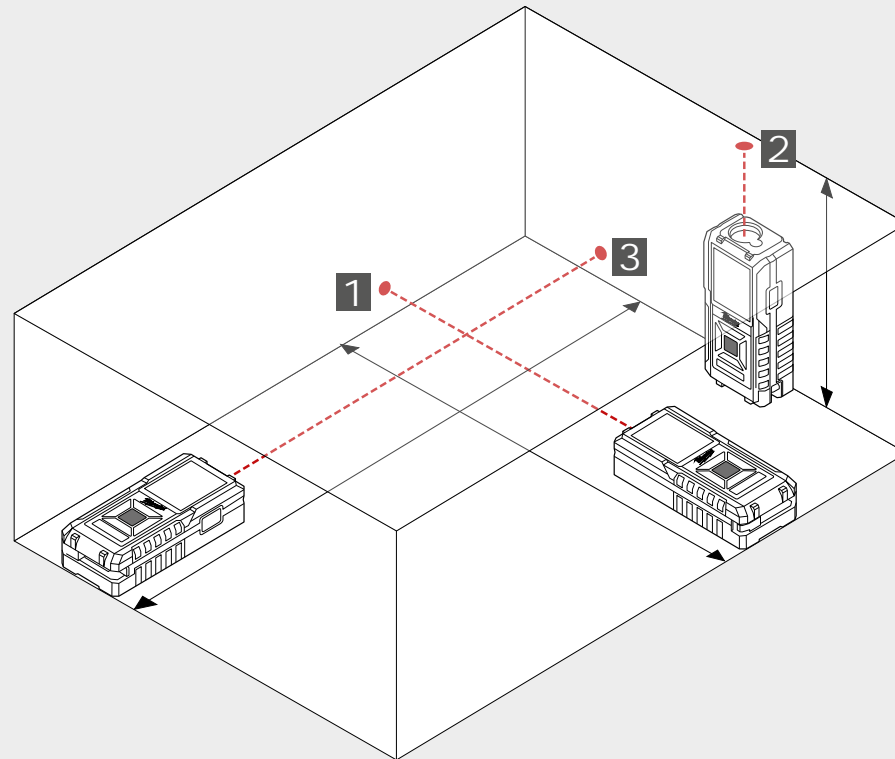
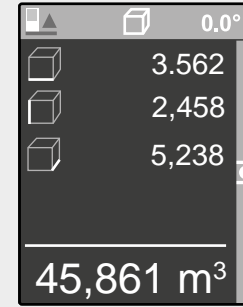
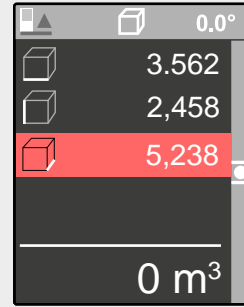
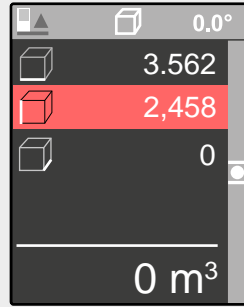
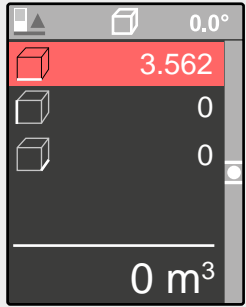
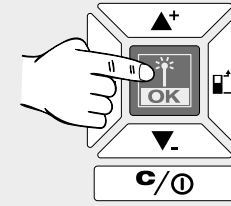
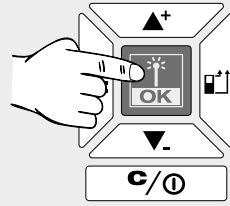
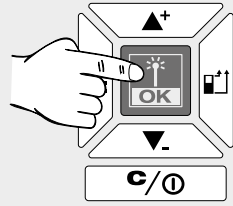

# INDIREKTE HÖHEN-/LÄNGENMESSUNG (NUR MIT LDM 100)

0

1

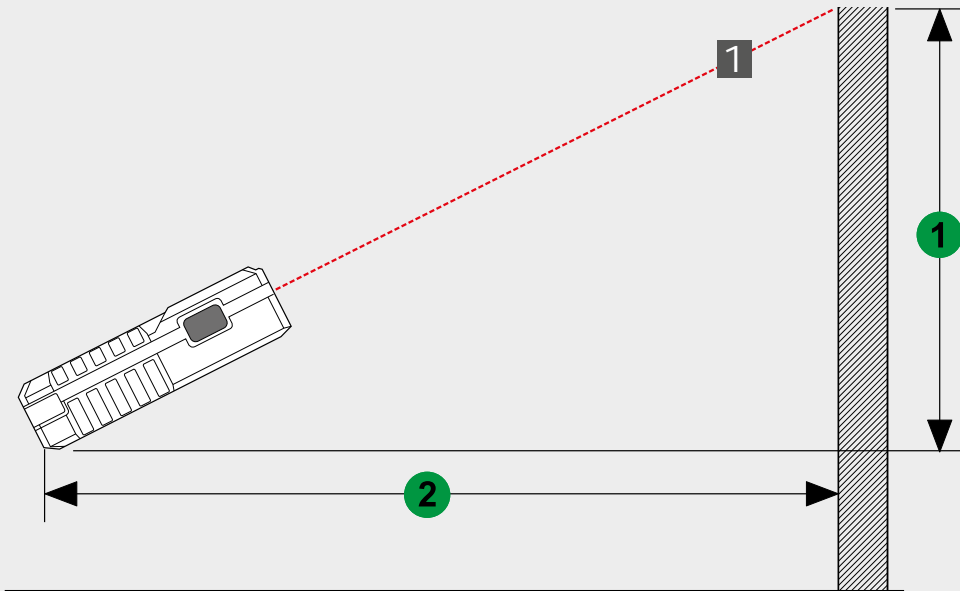
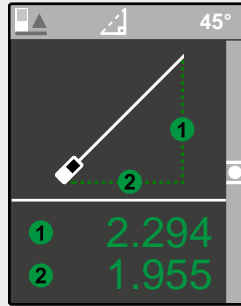
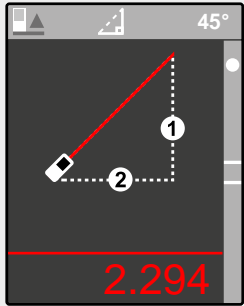
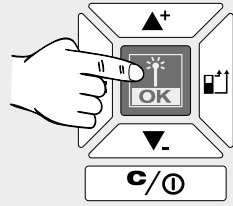



# INDIREKTE HÖHENMESSUNG (NUR MIT LDM 100)

0

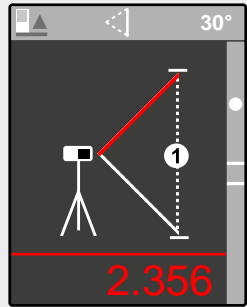

1

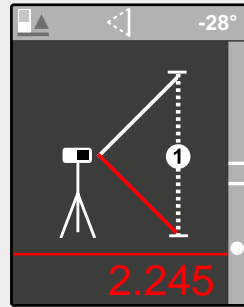
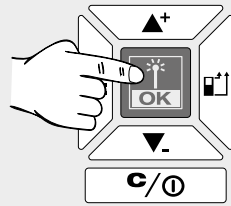

2

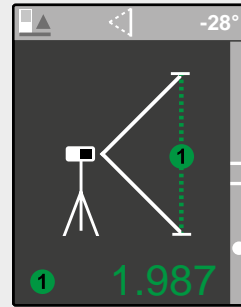
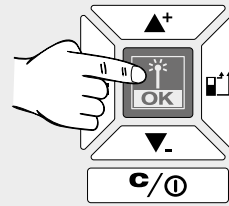

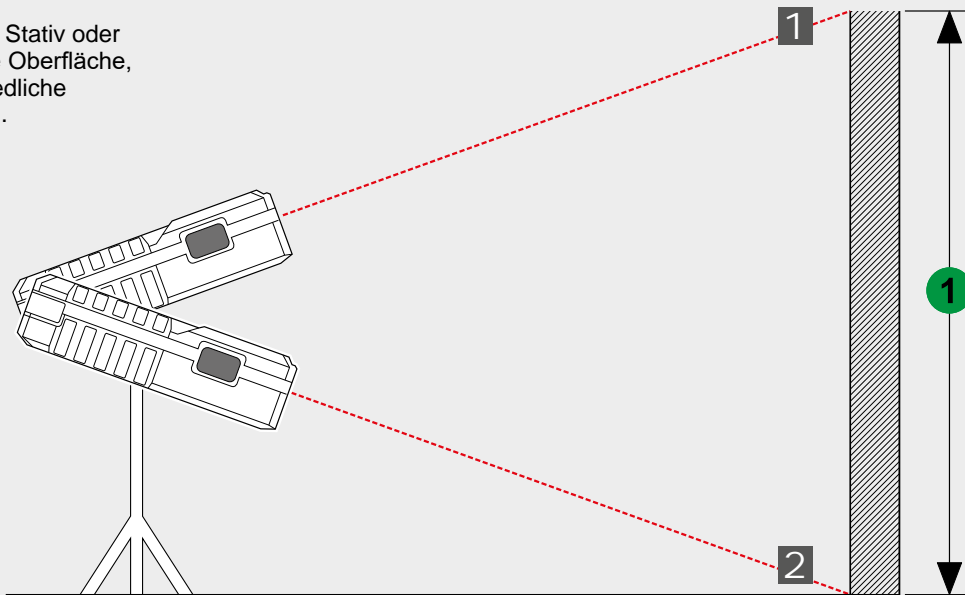

Verwenden Sie ein Stativ oder eine andere stabile Oberfläche, um zwei unterschiedliche Längen zu messen.



## TABLE DES MATIÈRES

Consignes de sécurité importantes .....	1
Caractéristiques techniques .....	2
Utilisation conforme aux prescriptions.....	2
Tables codes erreurs .....	2
Aperçu .....	3
Menu.....	5
Démarrer .....	6
Mesure longueur.....	7
Mesure surface.....	8
Mesure surface totale .....	9
Mesure volume .....	10
Mesure indirect hauteur/longueur (seulement avec l'LDM 100).....	11
Mesure indirect hauteur (seulement avec l'LDM 100).....	12

## CONSIGNES DE SÉCURITÉ IMPORTANTES

  N'utilisez pas ce produit avant d'avoir lu les consignes de sécurité et le manuel de l'utilisateur chargés sur le CD joint.

### Classement laser

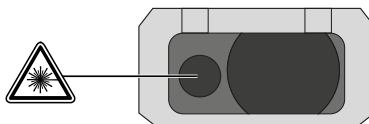

### AVERTISSEMENT:

Ce produit fait partie de la classe laser 2 au sens de la norme CEI 60825-1:2007.



APPAREIL LASER POUR CONSOMMATEURS FINAUX  
EN 50689:2021

#### Avis :

Éviter tout contact visuel direct. Le rayon laser peut causer un aveuglement temporaire type flash aux yeux.

Ne regardez pas dans le faisceau laser et ne le dirigez pas inutilement sur d'autres personnes.

N'éblouissez pas d'autres personnes.

#### Avis :

Ne pas employer le dispositif au laser près des enfants et ne pas permettre aux enfants d'employer le dispositif au laser

Attention ! Des surfaces réfléchissantes pourraient réfléchir le rayon laser sur l'opérateur ou sur des autres personnes.

Se tenir à distance des pièces en mouvement.

Effectuez régulièrement des mesures d'essai, en particulier avant, pendant et après des mesures importantes.

Attention: si le produit est défectueux, est tombé, a été utilisé de manière non conforme ou modifié, il peut fournir des mesures incorrectes

**Avis :** L'utilisation d'éléments de contrôle, de sélections ou l'exécution de procédures différentes de celles établies par le guide pourra comporter une dangereuse exposition aux rayons.

Le dispositif de mesure laser a une plage d'application limitée. (Voir chapitre "Données techniques"). Tout essai de mesure hors de la plage max. ou min. produira des résultats imprécis. L'utilisation en présence de conditions atmosphériques défavorables, telles que températures très hautes ou très basses, lumière solaire très intense, pluie, neige, brouillard ou toute autre condition limitant la visibilité, pourra comporter des mesures imprécises.

Si le dispositif de mesure laser est déplacé d'un site chaud à un site froid (ou vice-versa) il faut attendre pour permettre au dispositif de s'adapter à la nouvelle température ambiante.

Conserver toujours le dispositif de mesure laser dans un endroit fermé et le protéger contre les chocs, les vibrations et les températures extrêmes.

Protéger le dispositif de mesure laser contre les poussières, les liquides et la haute humidité de l'air. Les facteurs susdits pourraient endommager gravement les composants internes ou influencer négativement sa précision.

Ne pas utiliser des détergents agressifs ou des solvants. Nettoyer uniquement avec un chiffon propre et doux.

Éviter de forts chocs sur le dispositif de mesure laser ou sa chute. Après une chute du dispositif de mesure laser ou après son exposition à d'autres sollicitations mécaniques, il est nécessaire de contrôler la précision du dispositif.

Les réparations éventuellement nécessaires sur le dispositif au laser sont à effectuer exclusivement par du personnel spécialisé autorisé !

N'utilisez pas le produit dans des zones à risque d'explosion ou dans des environnements agros- sifs.

 Les déchets de piles et les déchets d'équipements électriques et électroniques (déchets d'équipements électriques et électroniques) ne sont pas à éliminer dans les déchets ménagers. Les déchets de piles et les déchets d'équipements électriques et électroniques doivent être collectés et éliminer séparément.

Retirez les déchets de piles, les déchets d'accumulateurs et les ampoules des appareils avant de les jeter.

S'adresser aux autorités locales ou au détaillant spécialisé en vue de connaître l'emplacement des centres de recyclage et des points de collecte.

Selon les réglementations locales, les détaillants peuvent être tenus de reprendre gratuitement les déchets de piles et les déchets d'équipements électriques et électroniques.

Contribuez à réduire la demande de matières premières en réutilisant et en recyclant vos déchets de piles et d'équipements électriques et électroniques.

Les déchets de piles (surtout les piles au lithium-ion) et les déchets d'équipements électriques et électroniques comportent des matériaux précieux et recyclables qui peuvent avoir des impacts négatifs sur l'environnement et sur votre santé s'ils ne sont pas éliminés de manière écologique.

Avant de mettre au rebut votre ancien appareil, supprimez les données personnelles qui pourraient s'y trouver.



 Marque de conformité européenne

 Marque de conformité britannique

 Marque de conformité ukrainienne

 Marque de conformité d'Eurasie

## CARACTÉRISTIQUES TECHNIQUES

	LDM 45	LDM 100
Optique	15 mm x 9 mm	18 mm
Plage de mesure		
Distance min.	0,05 m	0,05 m
Distance max.	45 m (Tolérance: 45,1 m)	100 m (Tolérance: 101 m)
Mesure distance		
Tolérance typique (elle vaut pour 100 % de réflectivité de l'objectif (mur peint en blanc), bas éclairage de fond, 25 °C)	± 2,0 mm (il faudrait considérer une tolérance supplémentaire de 0,1 mm/m)	± 2,0 mm (il faudrait considérer une tolérance supplémentaire de 0,1 mm/m)
Tolérance max. (elle vaut pour des objectifs avec réflectivité plus basse, éclairage plus élevé de fond ou températures proches à la limite inférieure / supérieure)	± 4,0 mm (il faudrait considérer une tolérance supplémentaire de 0,15 mm/m)	± 4,0 mm (il faudrait considérer une tolérance supplémentaire de 0,15 mm/m)
Unité min. affichable	1,0 mm	1,0 mm
Grandeur point laser		
Distance 16 m:	25 x 50 mm	25 x 50 mm
Classe laser	2	2
Type laser	635 nm, < 1 mW	635 nm, < 1 mW
Rayon laser		
angle vertical	+1 degré	+1 degré
angle horizontal	±1 degré	±1 degré
Afficheur type	LCD (31,5 mm x 40 mm)	LCD (31,5 mm x 40 mm)
Coupure automatique laser	90 secondes	90 secondes
Coupure automatique dispositif	180 secondes	180 secondes
Alimentation	AAA 2x (batterie alcaline)	AAA 2x (batterie alcaline)
Durée batterie	8000 (mesures individuelles)	8000 (mesures individuelles)
Filetage pour trépied	1/4"	1/4"
Plage température d'utilisation	de -0°C à +40°C	de -0°C à +40°C
Plage température de stockage	de -10°C à +60°C	de -10°C à +60°C
Poids sans batterie	87 g	122 g
Classe de protection	IP54 (protection contre les poussières et les projections d'eau)	IP54 (protection contre les poussières et les projections d'eau)

## UTILISATION CONFORME AUX PRESCRIPTIONS

Le dispositif de mesure laser est apte à mesurer des distances et des inclinaisons.

Comme déjà indiqué, cette machine n'est conçue que pour être utilisée conformément aux prescriptions.

## TABLES CODES ERREURS

Code	Description	Solution
Err500	Problèmes matériel	Désactiver et réactiver le télémètre. Si le problème persiste, remettre le télémètre au centre d'assistance le plus proche.

# APERÇU

## BARRE D'ÉTAT

- ▶ Point de mesure de référence, Type de mesure, Angle de mesure (seulement avec LDM 100), Niveau de mesure (seulement avec LDM 100)

## AFFICHEUR

- ▶ Menu
- ▶ Mesures
- ▶ Configurations

## VERS LE HAUT / ADDITIONNER

- ▶ Défiler le menu vers le haut
- ▶ Additionner la valeur

## MESURE / OK

- ▶ Activer le laser
- ▶ Sauvegarder la valeur mesurée
- ▶ Sélectionner OK dans le menu

## MENU

- ▶ Historique
- ▶ Mesure
- ▶ Configurations

## VERS LE BAS / SOUSTRAIRE

- ▶ Défiler le menu vers le bas
- ▶ Soustraire valeur

## EFFACER/ACTIVER/DÉSACTIVER

- ▶ ON / OFF (appuyer sur la touche jusqu'à l'émission d'un signal acoustique)
- ▶ Effacer la valeur mesurée

## POINT DE MESURE

- ▶ Postérieur (configuration défaut)
- ▶ Antérieur
- ▶ Angle (s'active automatiquement après la sortie de la pointe)



## MESURE

- ▶ Activer le laser
- ▶ Sauvegarder la valeur mesurée

## REPLACER LES BATTERIES

- ▶ Remplacer les batteries dès que le voyant de la batterie commence à clignoter.

1

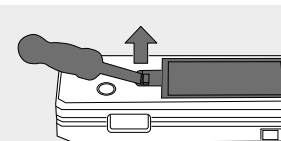

2

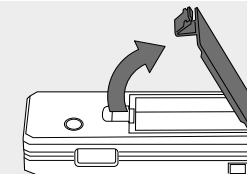

3

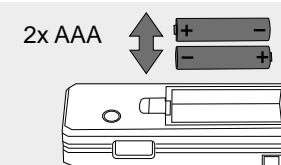

4

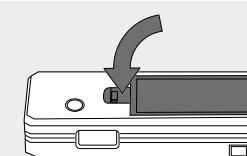

## CHEVALET

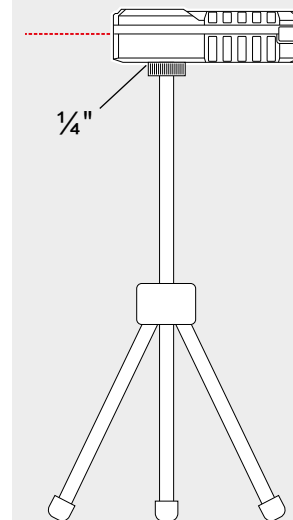

## POINTE POUR COINS

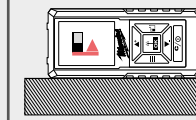
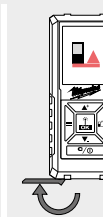
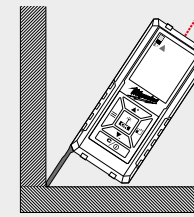

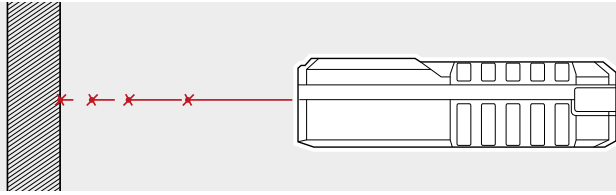

Le faisceau laser clignote en permanence pendant la mesure.

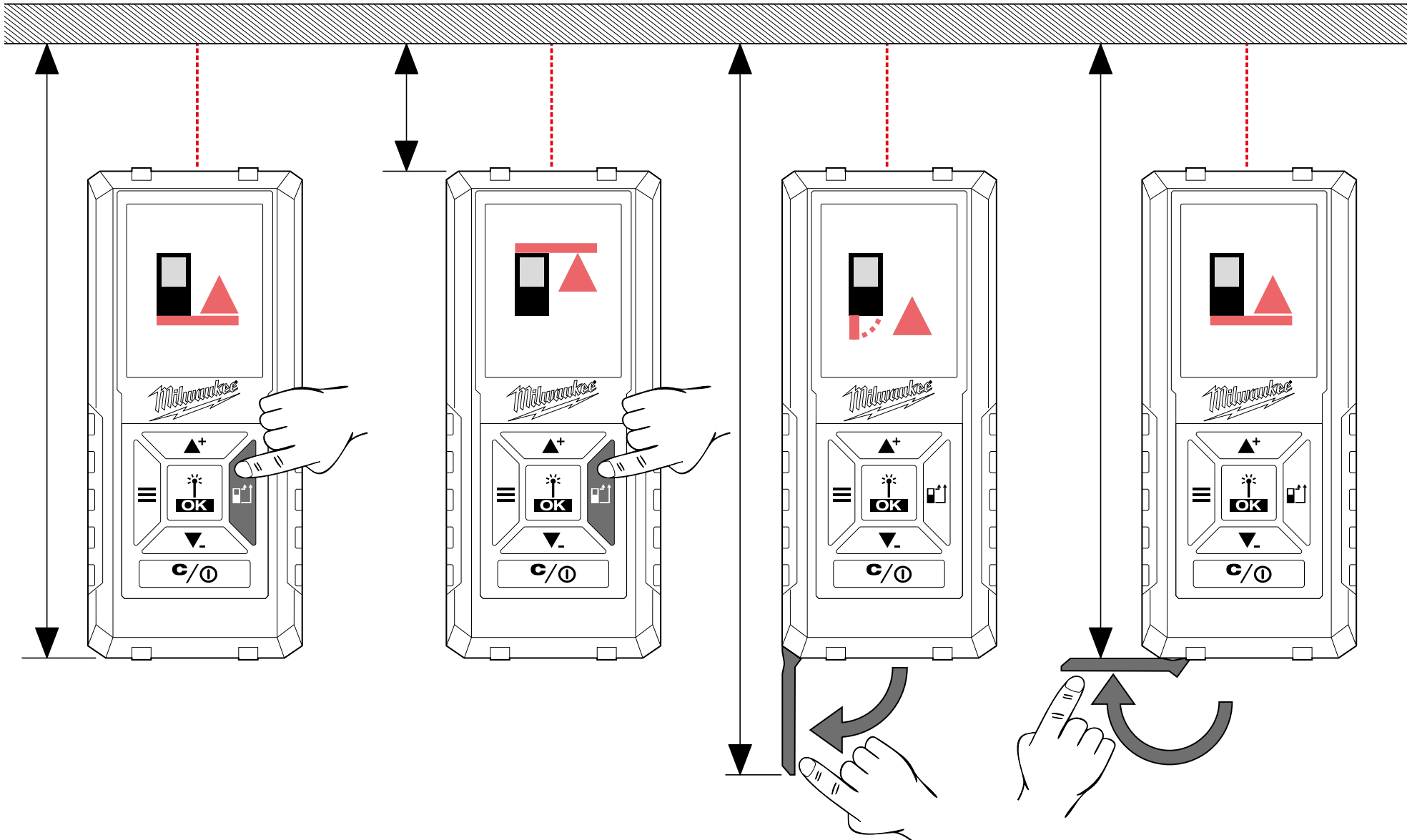

## MENU

### HISTORIQUE



Affichage des dernières 30 mesures / calculs  
Chaque mesure effectuée pour le calcul de la surface, de la surface totale, du volume, etc. n'est pas sauvegardée dans l'HISTORIQUE, mais le système sauvegarde uniquement le résultat des calculs.

Pour effacer une donnée, appuyer sur la touche C/ON/OFF.

Aux/des valeurs sauvegardées dans l'HISTORIQUE, il est possible d'additionner ou de soustraire des mesures / calculs. Uniquement des calculs de même type pourront être effectués (longueur, surface, volume, etc.).

Pour effectuer le calcul :

1. Utiliser les touches ▲+ ▼\_ pour sélectionner le mode de mesure dans l'HISTORIQUE.
2. Appuyer sur la touche OK.
3. Effectuer les mesures nécessaires au calcul.
4. Appuyer sur la touche OK pour sauvegarder le nouveau calcul dans l'HISTORIQUE.

### MESURE

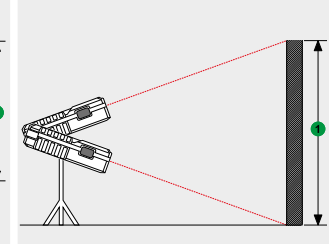
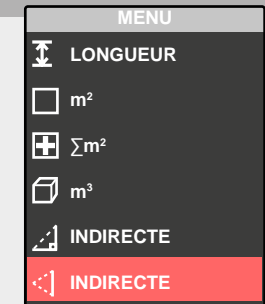
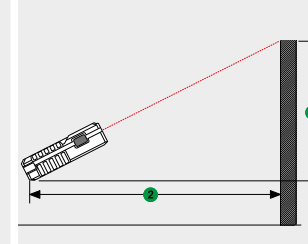
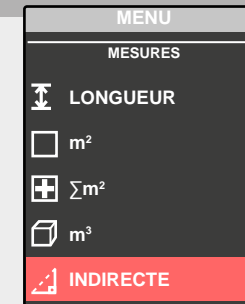
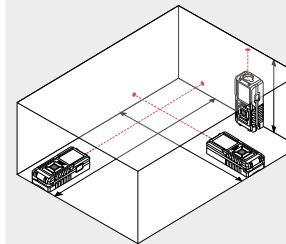
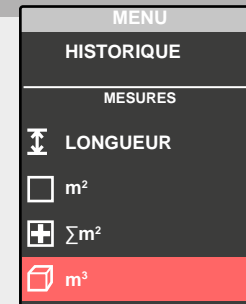
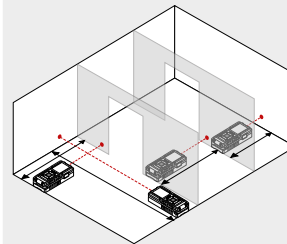
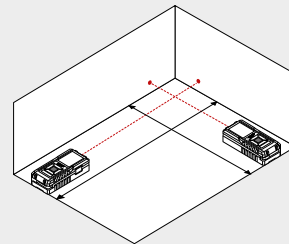
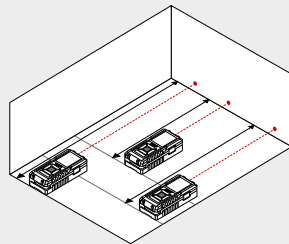

### CONFIGURATIONS



Sélectionner l'unité de mesure souhaitée.



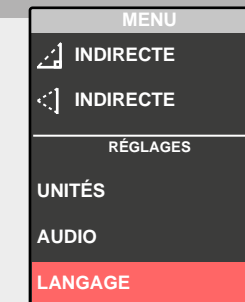

Signal acoustique ON/OFF.

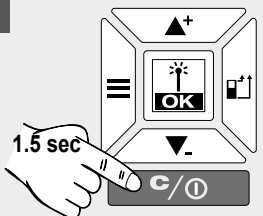
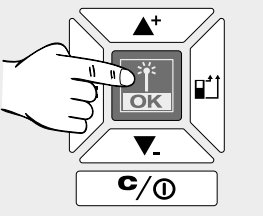
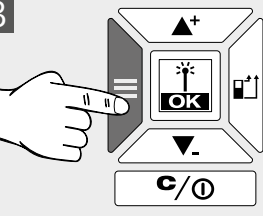
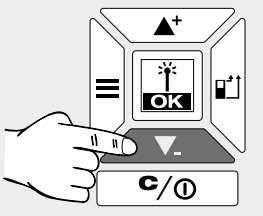
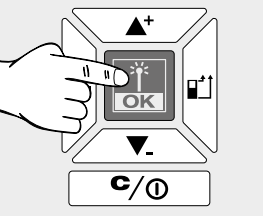
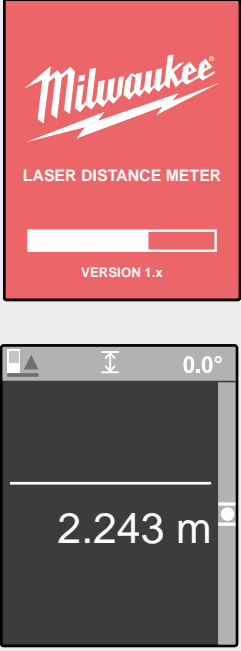
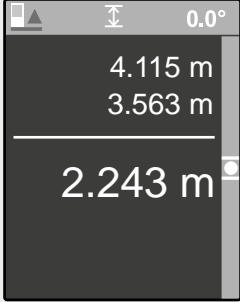

Sélectionner la langue

# DÉMARRER

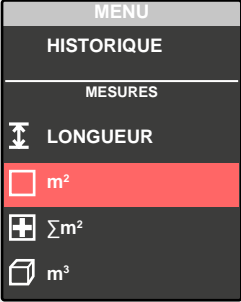
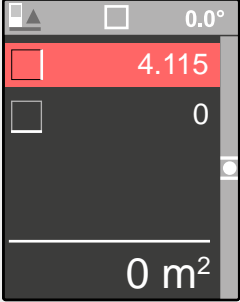
<p>1</p>  <p>1.5 sec</p>	<p>2</p> 	<p>3</p> 	<p>4</p> 	<p>5</p> 
				
<p>Lors de l'activation, LE MODE DE MESURE LONGUEUR sera activé automatiquement.</p>	<p>Effectuer une MESURE DE LONGUEUR ou ...</p>	<p>... appuyer sur la touche menu pour passer au menu ...</p>	<p>... et sélectionner un autre mode de fonctionnement à l'aide des touches ▲+ ▼- et ...</p>	<p>... activer ce mode de fonctionnement en appuyant sur la touche OK.</p>

# MESURE LONGUEUR

0



Valeur de mesure blanche =  
valeur mesurée

1

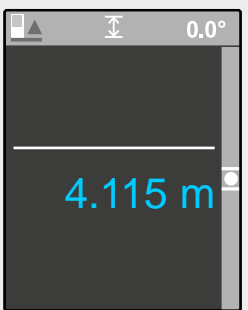
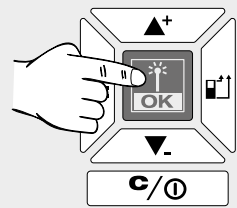

Valeur de mesure bleue =  
sauvegardée temporairement

2

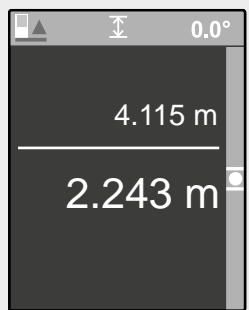
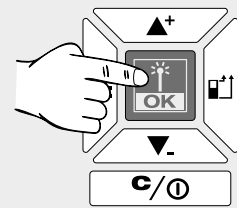

3

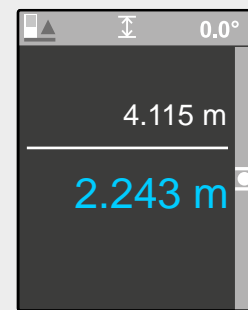
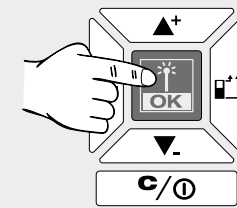

4

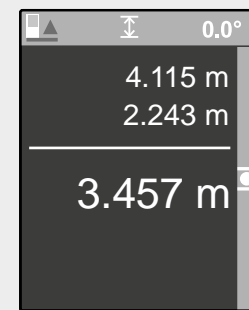
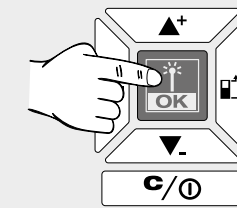

5

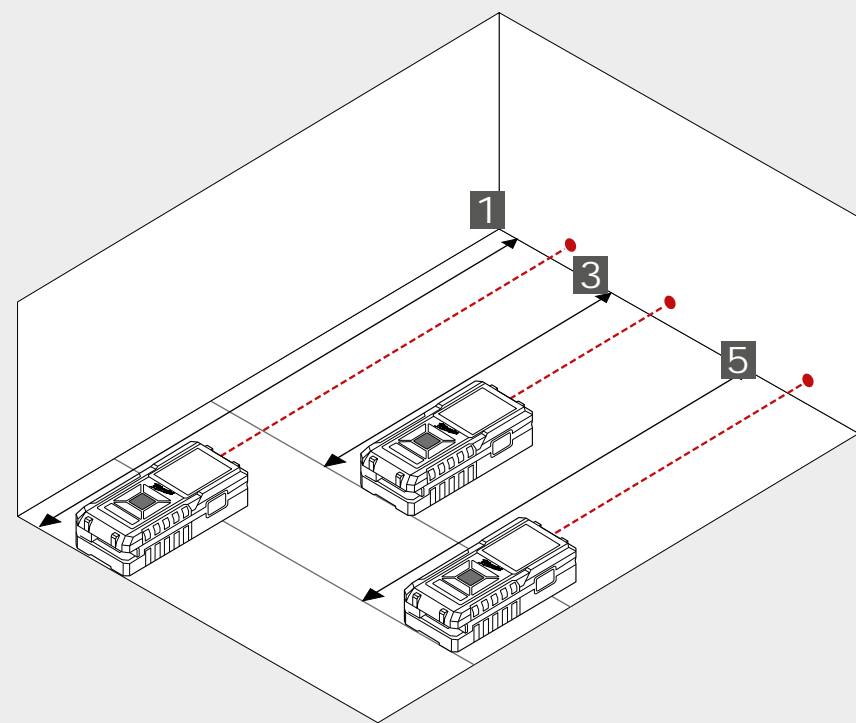
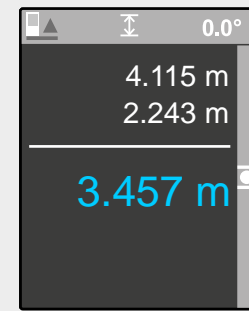
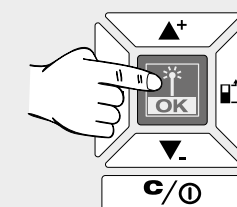



0

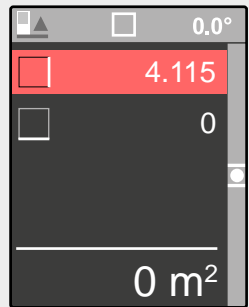

1

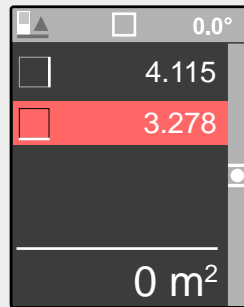
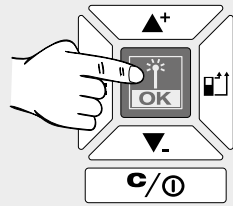

2

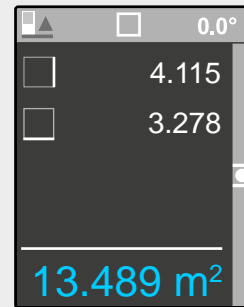
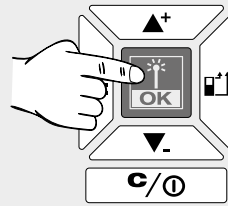

2

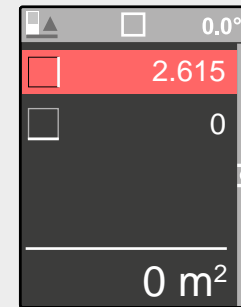
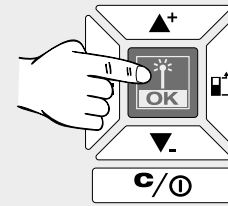

Nouvelle mesure  
La valeur sera sauvegardée dans  
l'HISTORIQUE

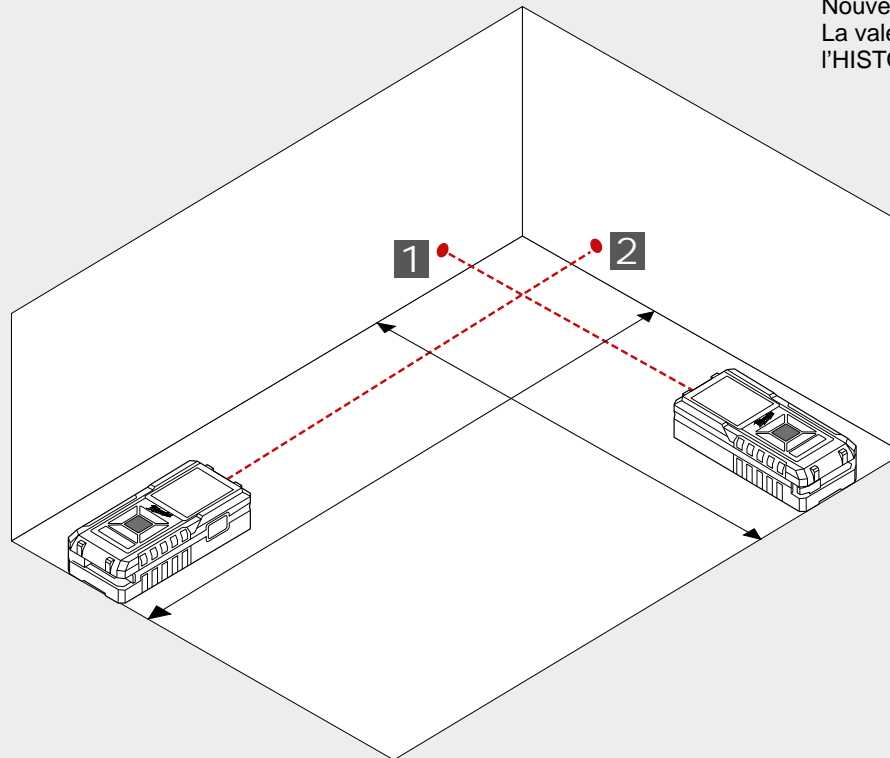

# MESURE SURFACE TOTALE

0

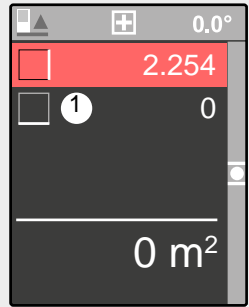

1

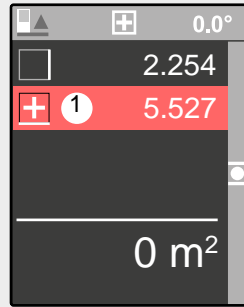
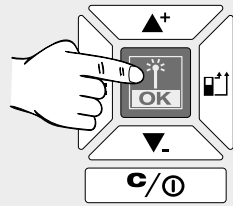

2

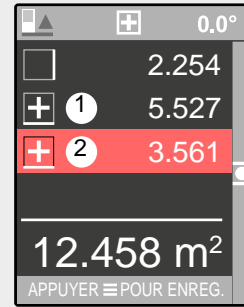
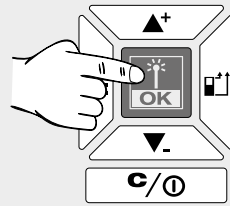

3

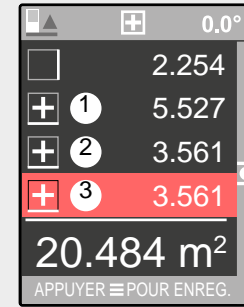
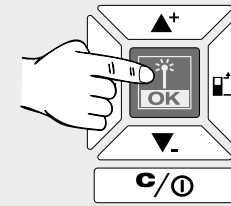

4

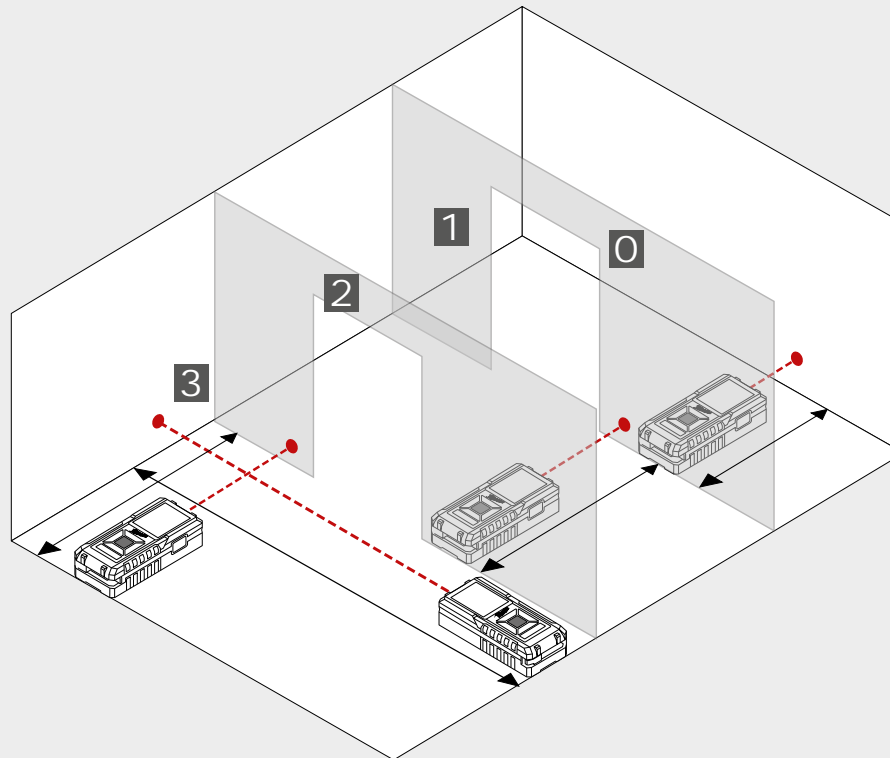
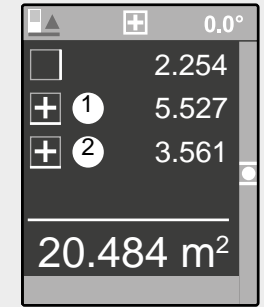
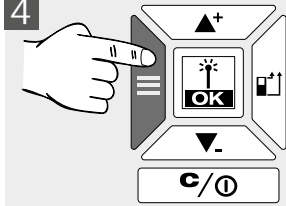

4

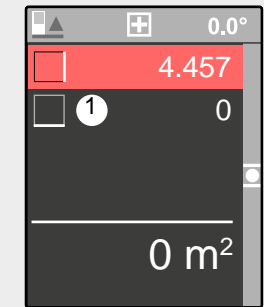
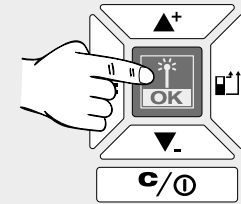

Nouvelle mesure  
Le résultat sera sauvegardé dans l'HISTORIQUE

0

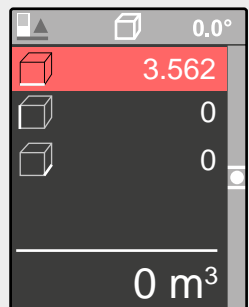

1

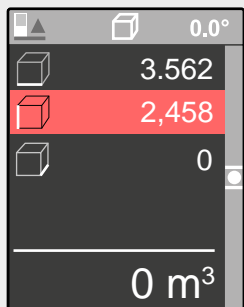
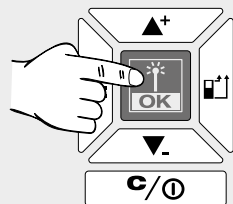

2

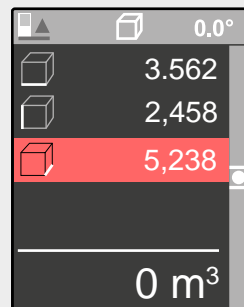
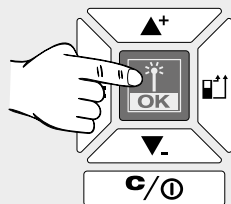

3

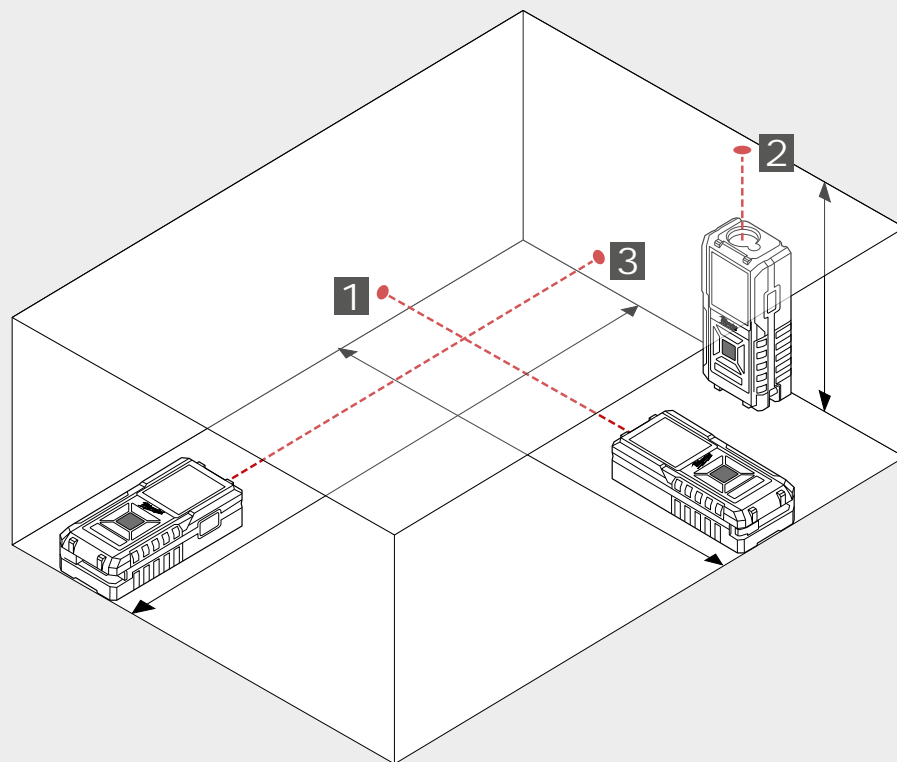
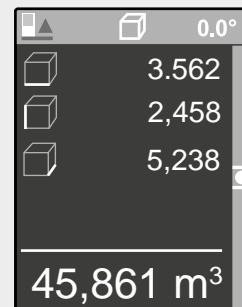
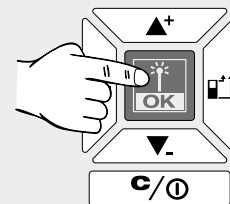

0

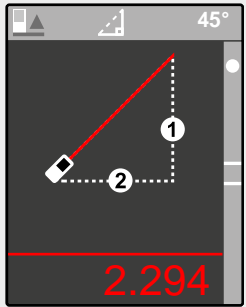

1

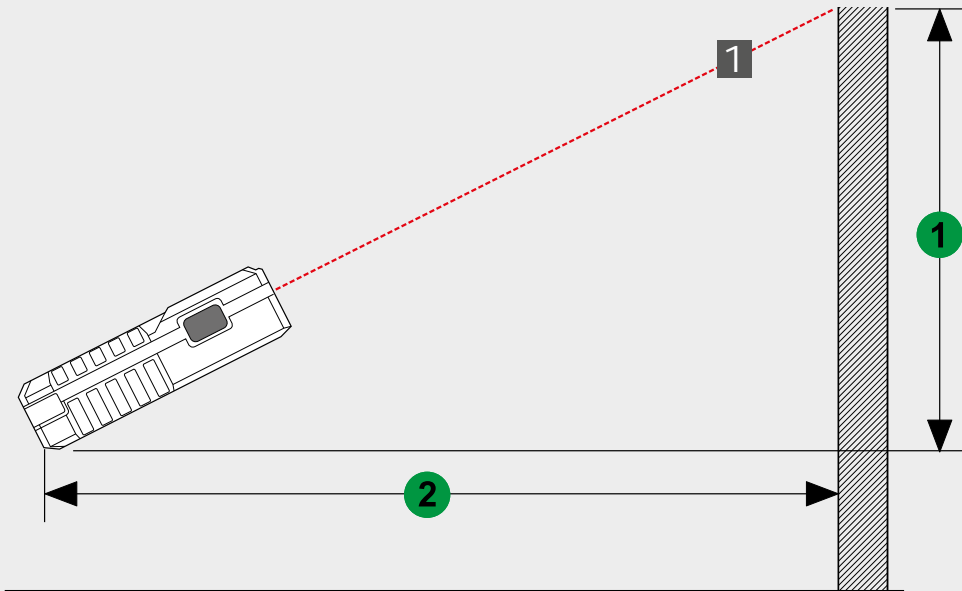
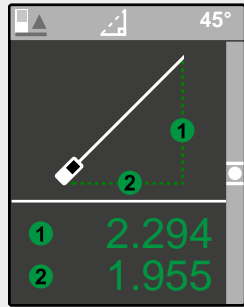
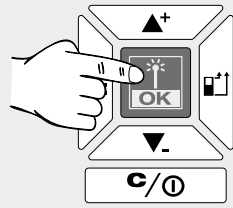

# MESURE INDIRECTE HAUTEUR (SEULEMENT AVEC L'LDM 100)

0

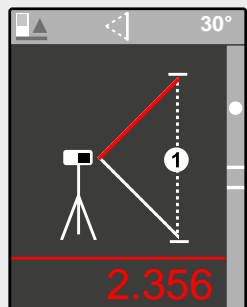

1

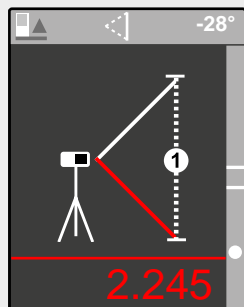
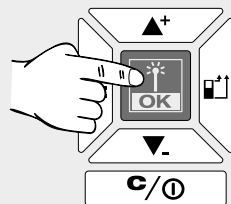

2

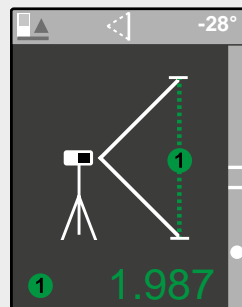
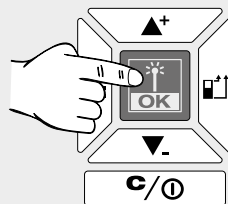

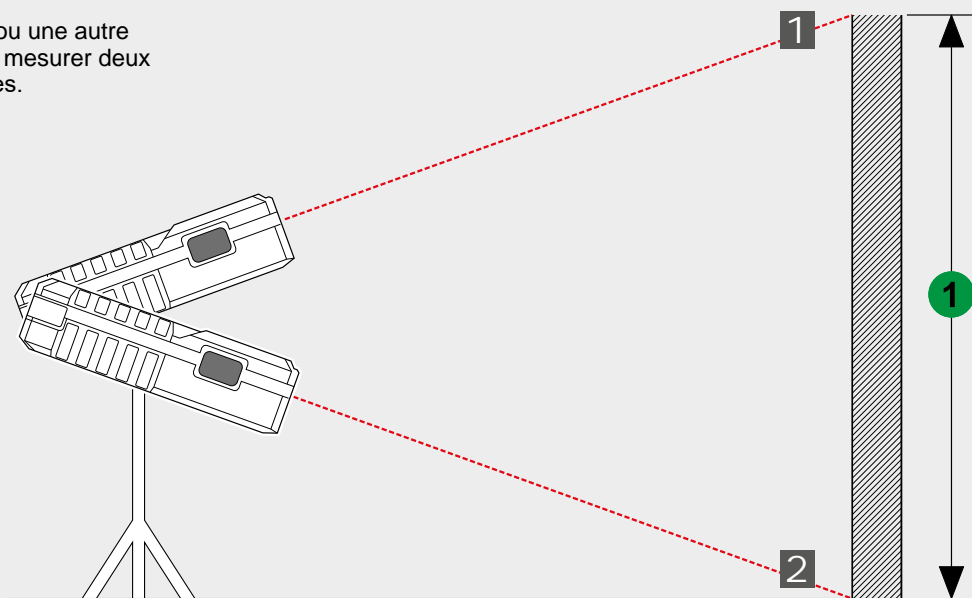

Utiliser le chevalet ou une autre surface stable pour mesurer deux longueurs différentes.



## INDICE

Importanti istruzioni di sicurezza .....	1
Dati tecnici .....	2
Utilizzo conforme .....	2
Tabella codici errori.....	2
Panoramica .....	3
Punto di misurazione .....	4
Menu.....	5
Inizia .....	6
Misurazione lunghezza.....	7
Misurazione superficie.....	8
Misurazione superficie complessiva .....	9
Misurazione volume.....	10
Misurazione indiretta altezza/lunghezza (solo con l'LDM 100).....	11
Misurazione indiretta altezza (solo con l'LDM 100) .....	12

## IMPORTANTI ISTRUZIONI DI SICUREZZA

  Non usare il prodotto prima di avere studiato le Istruzioni di sicurezza e il Manuale d'uso sul CD in allegato.

### Classifica laser

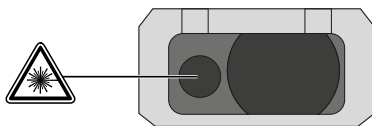

### AVVERTENZA:

Si tratta di un prodotto laser di classe 2 conforme a EN60825-1:2014



DISPOSITIVO LASER PER UTENTI FINALI  
EN 50689:2021

### Avvertenza:

Evitare qualsiasi contatto visivo diretto. Il raggio laser può causare un accecamento temporaneo da flash agli occhi.

Non fissare il raggio laser né puntarlo verso altri senza motivo.

Non abbagliare altre persone.

### Avvertenza:

Non usare il dispositivo a laser nelle vicinanze di bambini e non permettere ai bambini di usare il dispositivo a laser.

Attenzione! Superfici riflettenti potrebbero fare riflettere il raggio laser sull'operatore o su altre persone.

Tenere le estremità a una distanza di sicurezza.

Effettuare periodicamente delle misure di controllo, soprattutto prima, durante e dopo misurazioni di particolare importanza.

Se il prodotto è difettoso, è caduto, è stato usato in modo improprio o modificato potrebbe fornire misurazioni errate.

**Avvertenza:** L'uso di elementi di controllo, di impostazioni oppure l'esecuzione di procedimenti diversi da quelli stabiliti nel manuale può comportare una pericolosa esposizione ai raggi.

Il dispositivo di misura a laser ha un range di applicazione limitato. (Vedi il capitolo Dati tecnici). Tentativi di misurare al di fuori del range massimo e minimo causano imprecisioni. L'uso in presenza di condizioni atmosferiche avverse, come temperature eccessivamente alte o basse, luce solare molto intensa, pioggia, neve, nebbia o altre condizioni che limitano la visibilità, può comportare misurazioni imprecise.

Se il dispositivo di misura a laser viene portato da un ambiente caldo in un ambiente freddo (o vice-versa), attendere che il dispositivo si adatti alla nuova temperatura ambiente.

Conservare il dispositivo di misura a laser sempre in ambienti chiusi, proteggerlo da urti, vibrazioni e temperature estreme.

Proteggere il dispositivo di misura a laser da polveri, liquidi ed elevata umidità dell'aria. I suddetti fattori potrebbero danneggiare gravemente i componenti interni o influenzare negativamente la precisione.

Non usare detergenti aggressivi o solventi. Pulire soltanto con un panno pulito, morbido.

Evitare forti urti sul dispositivo di misura a laser o la sua caduta. Dopo una caduta del dispositivo di misura a laser o dopo una sua esposizione ad altre sollecitazioni meccaniche è necessario verificare la precisione del dispositivo.

Le riparazioni eventualmente necessarie sul dispositivo a laser devono essere eseguite esclusivamente da personale specializzato autorizzato!

Non azionare il prodotto in aree a rischio di esplosione o in ambienti aggressivi.

 I rifiuti di pile e i rifiuti di apparecchiature elettriche ed elettroniche non devono essere smaltiti insieme ai rifiuti domestici. I rifiuti di pile e di apparecchiature elettriche ed elettroniche devono essere raccolti e smaltiti separatamente.

Rimuovere i rifiuti di pile e di accumulatori nonché le sorgenti luminose dalle apparecchiature prima di smaltirle.

Chiedere alle autorità locali o al rivenditore specializzato dove si trovano i centri di riciclaggio e i punti di raccolta.

A seconda dei regolamenti locali, i rivenditori al dettaglio possono essere obbligati a ritirare gratuitamente i rifiuti di pile e i rifiuti di apparecchiature elettriche ed elettroniche.

Aiutate a ridurre il fabbisogno di materie prime riutilizzando e riciclando i propri rifiuti di pile e di apparecchiature elettriche ed elettroniche.

I rifiuti di pile (specialmente di pile agli ioni di litio) e i rifiuti di apparecchiature elettriche ed elettroniche contengono materiali preziosi e riciclabili che possono avere un impatto negativo sull'ambiente e sulla vostra salute se non vengono smaltiti in modo ecologico.

Cancelare tutti i dati personali che potrebbero essere presenti sul vostro rifiuto di apparecchiatura prima di procedere allo smaltimento.

 Marchio di conformità europeo

 Marchio di conformità britannico

 Marchio di conformità ucraino

 Marchio di conformità euroasiatico

## DATI TECNICI

	LDM 45	LDM 100
Ottica	15 mm x 9 mm	18 mm
Gamma di misura		
Distanza minima	0,05 m	0,05 m
Distanza massima	45 m (Tolleranza: 45,1 m)	100 m (Tolleranza: 101 m)
Misurazione distanza		
Tolleranza tipica (vale per 100 % di riflettanza dell'obiettivo (parete verniciata bianca), bassa illuminazione dello sfondo, 25 °C)	± 2,0 mm (si dovrebbe considerare una tolleranza aggiuntiva di 0,1 mm/m)	± 2,0 mm (si dovrebbe considerare una tolleranza aggiuntiva di 0,1 mm/m)
Tolleranza massima (vale per obiettivi con riflettanza minore, elevata illuminazione dello sfondo o temperature vicine al limite inferiore/superiore)	± 4,0 mm (si dovrebbe considerare una tolleranza aggiuntiva di 0,15 mm/m)	± 4,0 mm (si dovrebbe considerare una tolleranza aggiuntiva di 0,15 mm/m)
Unità minima visualizzabile	1,0 mm	1,0 mm
Grandezza punto laser		
Distanza 16 m:	25 x 50 mm	25 x 50 mm
Classe laser	2	2
Tipo laser	635 nm, < 1 mW	635 nm, < 1 mW
Raggio laser		
angolo verticale	+1 grado	+1 grado
angolo orizzontale	±1 grado	±1 grado
Display tipo	LCD (31,5 mm x 40 mm)	LCD (31,5 mm x 40 mm)
Disattivazione automatica laser	90 secondi	90 secondi
Disattivazione automatica dispositivo	180 secondi	180 secondi
Alimentazione	AAA 2x (batteria alcalina)	AAA 2x (batteria alcalina)
Durata batteria	8000 (misurazione singola)	8000 (misurazione singola)
Filettatura del treppiede	1/4"	1/4"
Range temperatura di lavoro	da -0°C a +40°C	da -0°C a +40°C
Range temperatura di immagazzinaggio	da -10°C a +60°C	da -10°C a +60°C
Peso senza batteria	87 g	122 g
Classe di protezione	IP54 (protezione da polveri e spruzzi d'acqua)	IP54 (protezione da polveri e spruzzi d'acqua)

## UTILIZZO CONFORME

Il dispositivo di misura a laser è atto a misurare distanze ed inclinazioni.

Utilizzare il prodotto solo per l'uso per cui è previsto.

## TABELLA CODICI ERRORI

Codice	Descrizione	Soluzione
Err500	Problemi hardware	Spegnere e riaccendere il misuratore. Se il problema persiste, portare il misuratore al più vicino centro di assistenza.

## BARRA DI STATO

- ▶ Punto misurazione di riferimento, Tipo di misurazione, Angolo di misurazione (solo con LDM 100), Livello di misurazione (solo con LDM 100)

## DISPLAY

- ▶ Menu
- ▶ Misurazioni
- ▶ Impostazioni

## VERSO SU / SOMMARE

- ▶ Andare verso su nel menu
- ▶ Sommare il valore

## MISURAZIONE / OK

- ▶ Accendi il laser
- ▶ Salva il valore misurato
- ▶ Seleziona OK nel menu

## MENU

- ▶ Storico
- ▶ Misurazione
- ▶ Impostazioni

## VERSO GIÙ / SOTTRARRE

- ▶ Andare verso giù nel menu
- ▶ Sottrai valore

## CANCELLA/ACCENDI/SPEGNI

- ▶ ON / OFF (tenere premuto il tasto fino a quando il dispositivo non emetterà un segnale acustico)
- ▶ Cancella il valore misurato

## PUNTO DI MISURAZIONE

- ▶ Posteriore (impostazione default)
- ▶ Anteriore
- ▶ Angolo (si attiva automaticamente estraendo la punta)



## MISURA

- ▶ Accendi il laser
- ▶ Salva il valore misurato

## SOSTITUISCI LE BATTERIE

- ▶ Sostituire le batterie non appena il simbolo della batteria inizia a lampeggiare.

1

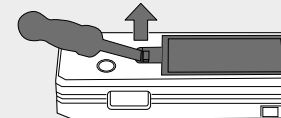

2

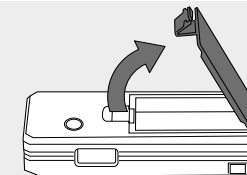

3

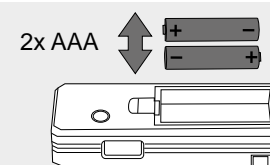

4

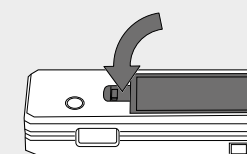

## CAVALLETTO

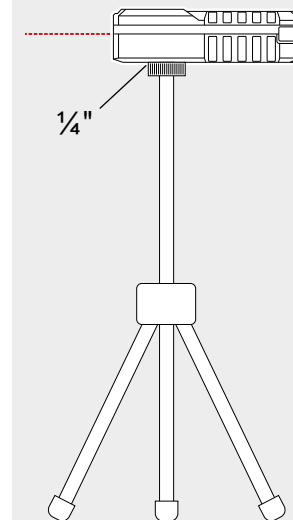

## PUNTA PER ANGOLI

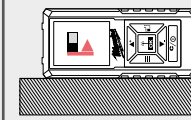
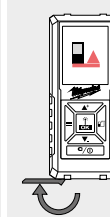
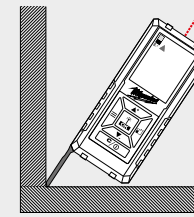



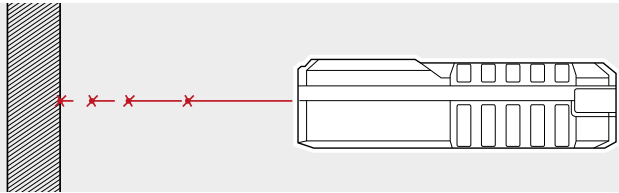

Durante la misurazione il raggio laser lampeggia in modo continuativo.

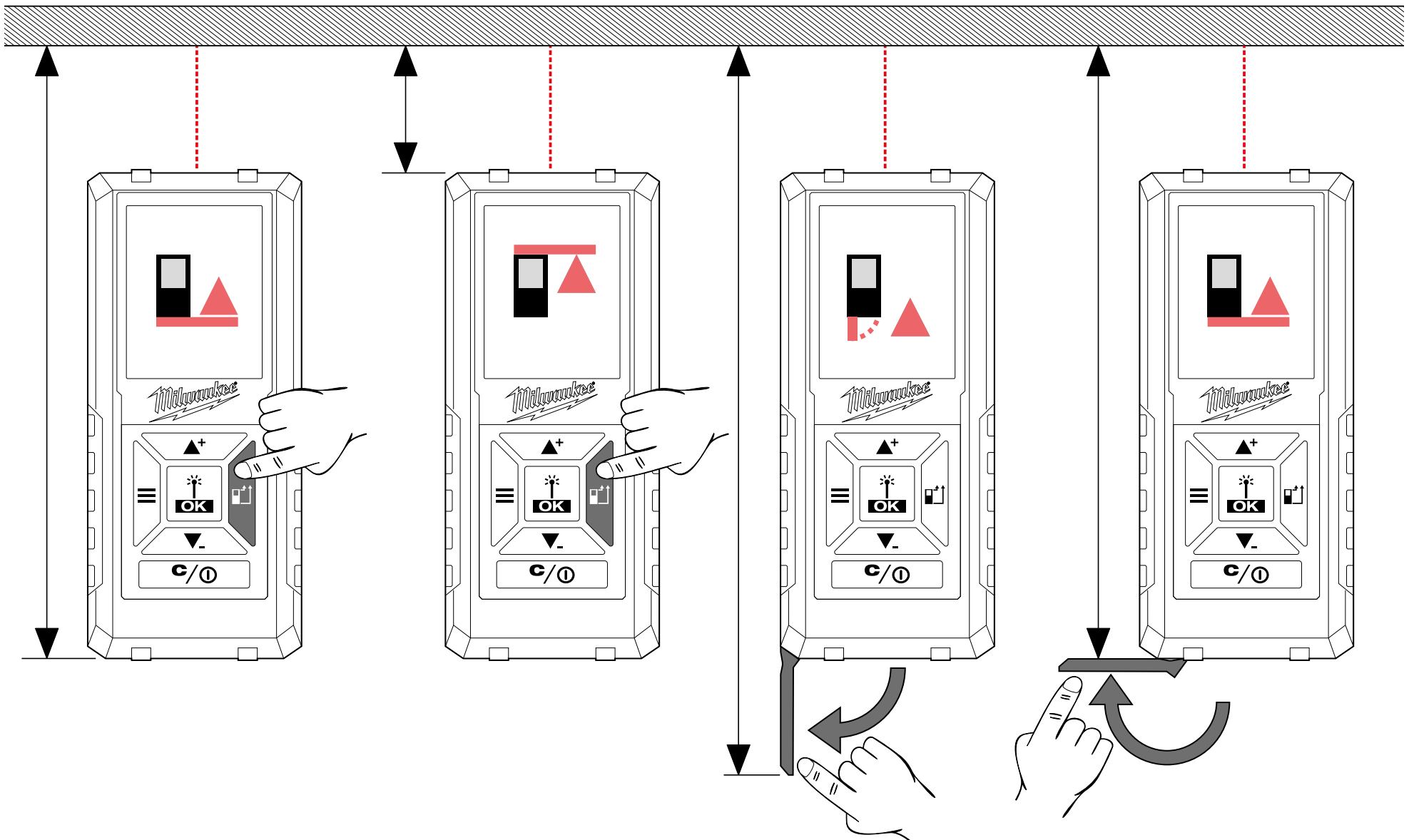

# MENU

## STORICO



Visualizzazione delle ultime 30 misurazioni / calcoli

Le singole misurazioni effettuate per il calcolo di superficie, superficie complessiva, volume, ecc. non vengono salvate nello STORICO, ma soltanto il risultato dei calcoli.

Per cancellare un dato, premere il tasto C/ON/OFF.

Ai/dai valori salvati nello STORICO è possibile sommare o sottrarre misurazioni/calcoli. Possono essere eseguiti soltanto calcoli dello stesso tipo (lunghezza, superficie, volume, ecc.).

Per eseguire un calcolo:

1. Usa i tasti ▲+ ▼- per selezionare una modalità di misurazione dallo STORICO.
2. Premi il tasto OK.
3. Esegui le misurazioni necessarie al calcolo.
4. Premi il tasto OK per salvare il nuovo calcolo nello STORICO.

## MISURAZIONE

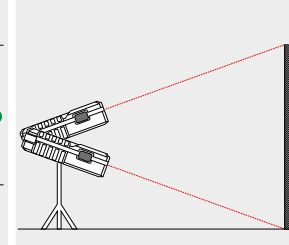
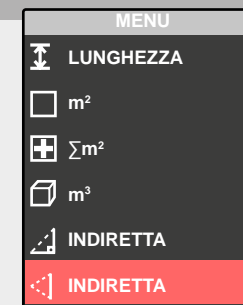
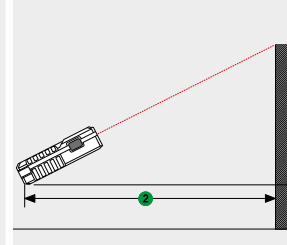
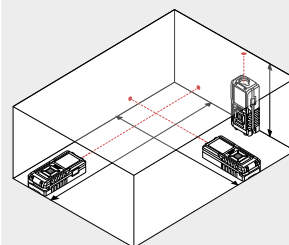
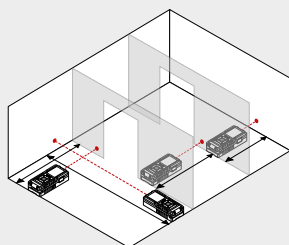
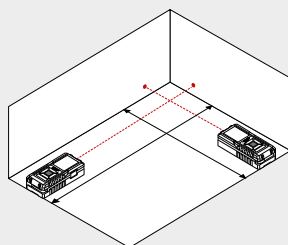
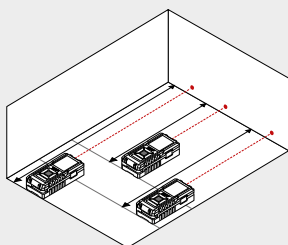

## IMPOSTAZIONI





Seleziona l'unità di misura desiderata.





Segnale acustico ON/OFF.

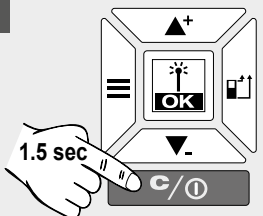
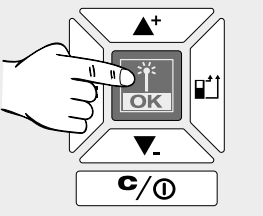
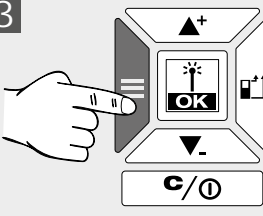
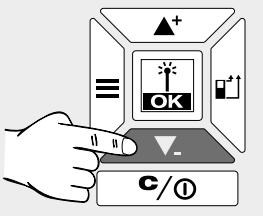
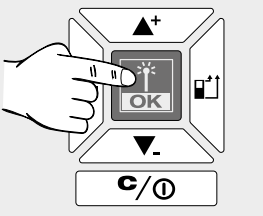
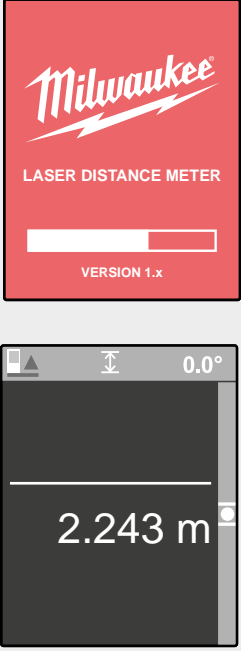
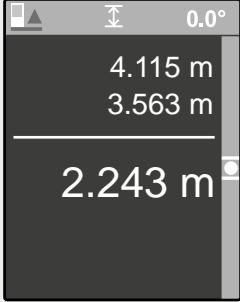

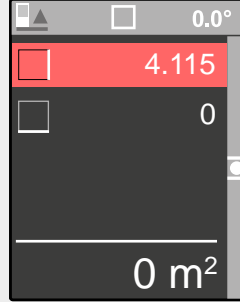
Seleziona la lingua

<p>1</p> 	<p>2</p> 	<p>3</p> 	<p>4</p> 	<p>5</p> 
				
<p>All'accensione viene attivata automaticamente la MODALITÀ DI MISURAZIONE LUNGHEZZA.</p>	<p>Esegui una MISURAZIONE DI LUNGHEZZA oppure ...</p>	<p>... premi il tasto menu per passare al menu ...</p>	<p>... e seleziona un'altra modalità di funzionamento con i tasti ▲+ ▼- e ...</p>	<p>... attiva questa modalità di funzionamento premendo il tasto OK.</p>

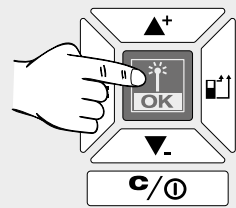
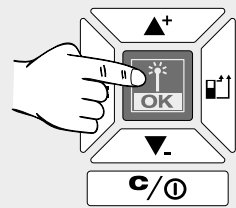
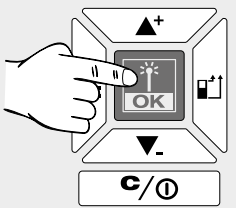
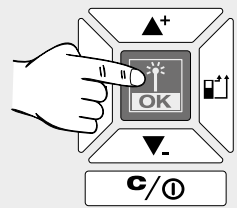
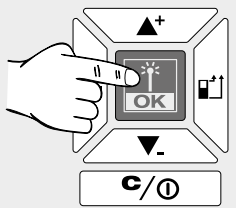
# MISURAZIONE LUNGHEZZA

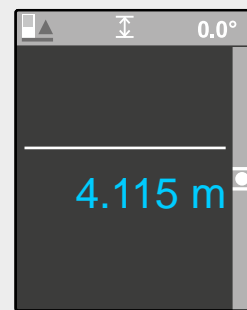
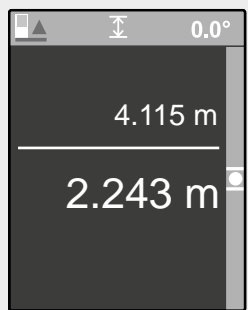
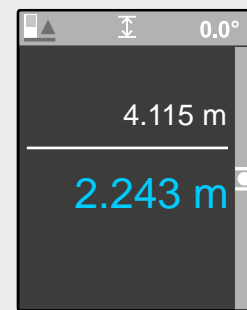
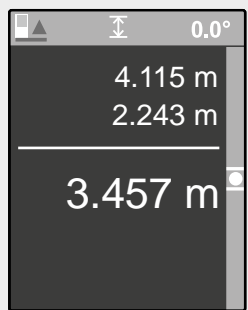
<p>0</p> 	<p>1</p> 	<p>2</p> 	<p>3</p> 	<p>4</p> 
 <p>Valore di misurazione bianco = valore misurato</p>	 <p>Valore di misurazione blu = salvato provvisoriamente</p>			

5

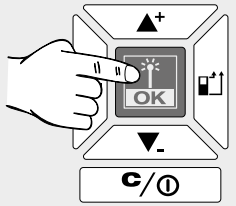
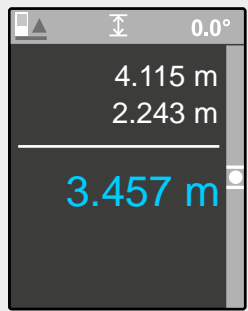
0

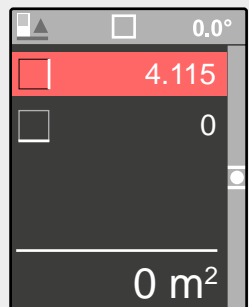

1

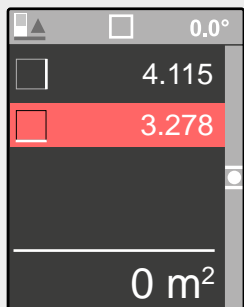
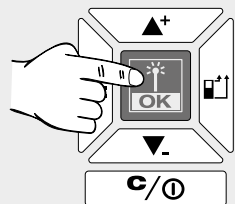

2

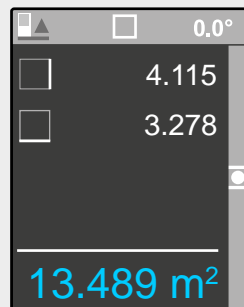
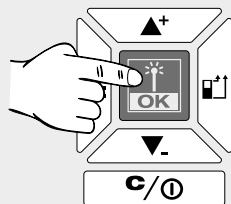

2

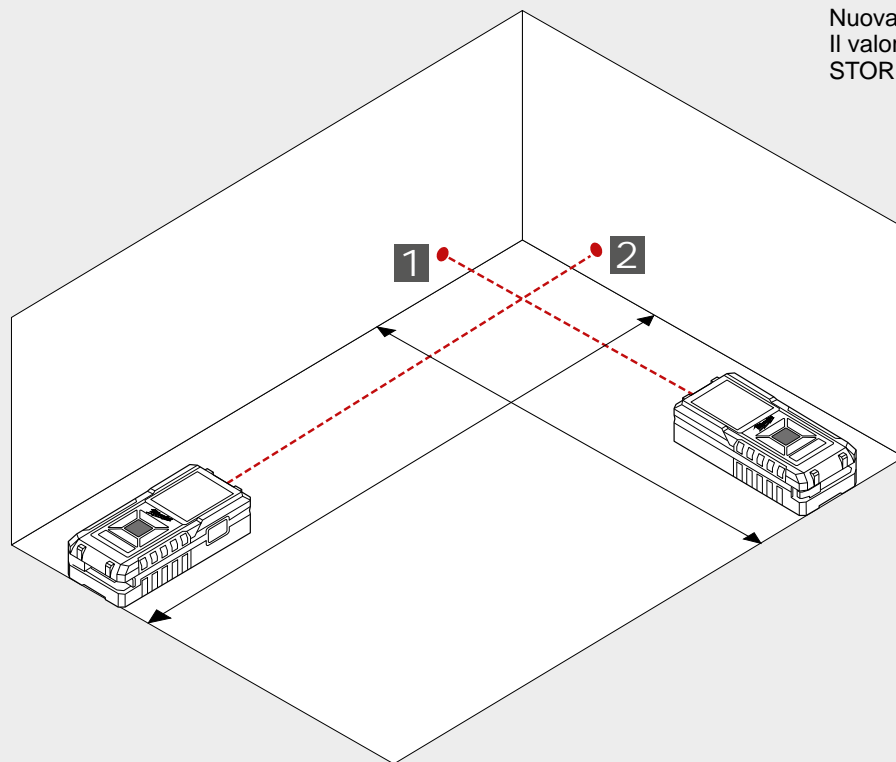
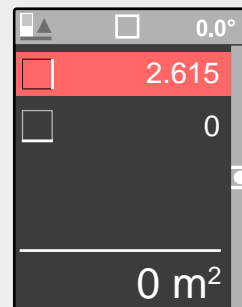
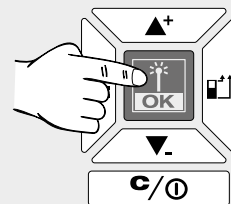

Nuova misurazione  
Il valore viene salvato nello  
STORICO

# MISURAZIONE SUPERFICIE COMPLESSIVA

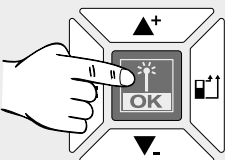
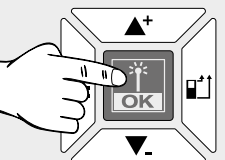
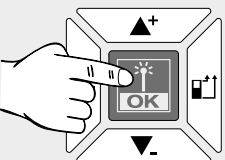
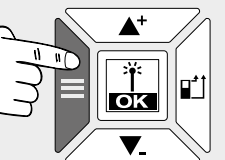
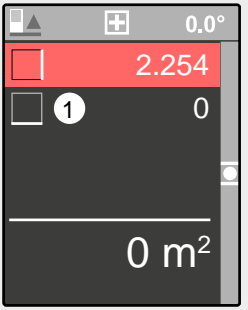
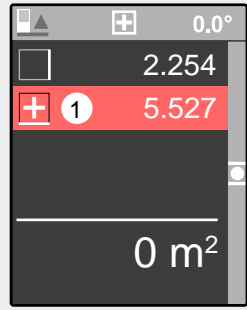
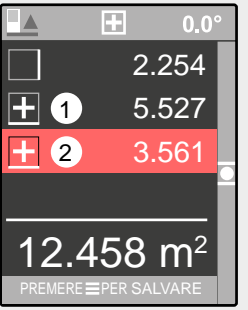
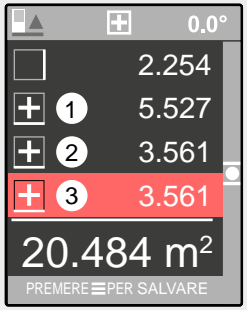
<p>0</p>  <p><b>C/0</b></p>	<p>1</p>  <p><b>C/0</b></p>	<p>2</p>  <p><b>C/0</b></p>	<p>3</p>  <p><b>C/0</b></p>
			

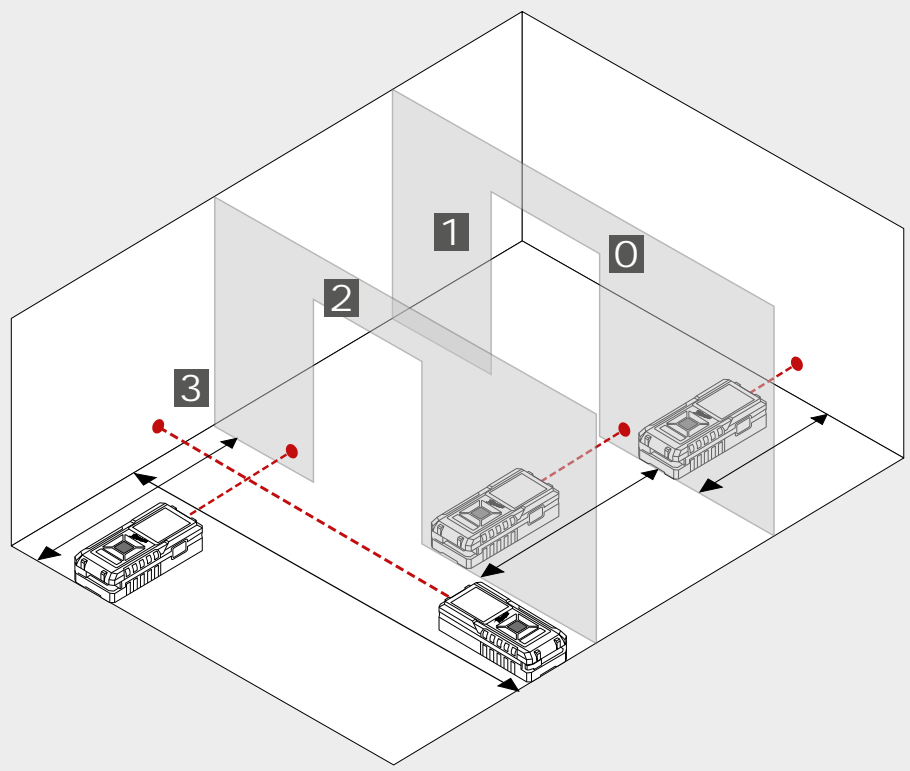

4



**C/0**



Nuova misurazione  
Il risultato viene salvato nello  
STORICO

# MISURAZIONE VOLUME

0

1

2

3

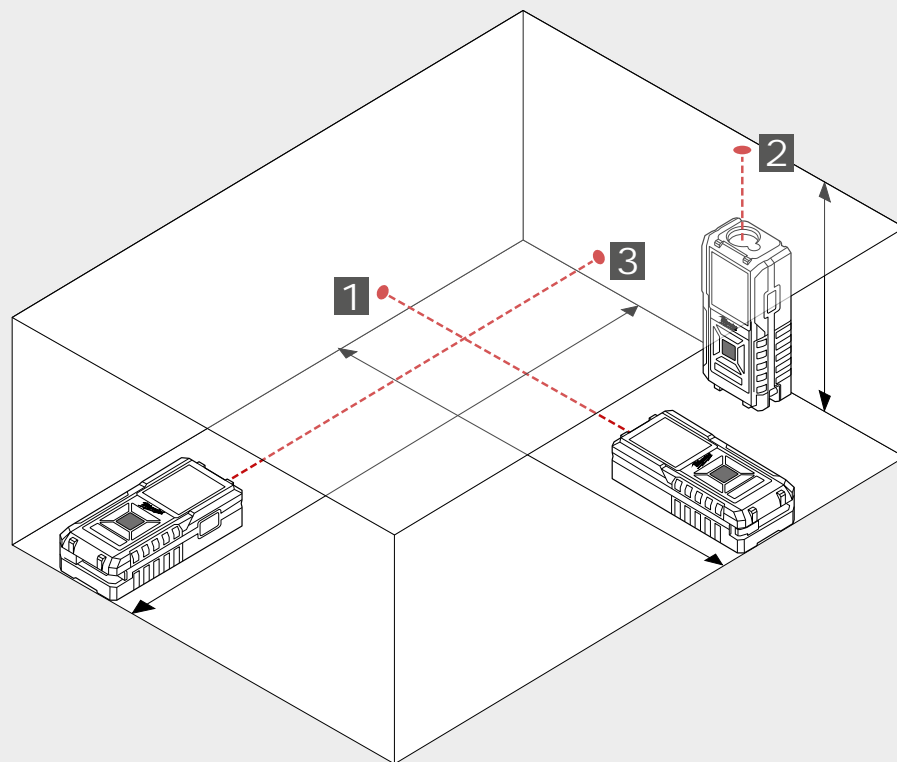
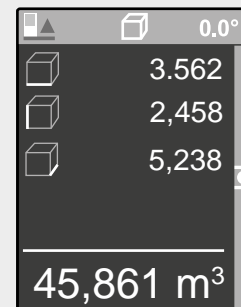
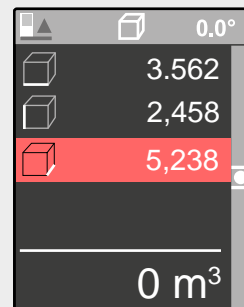
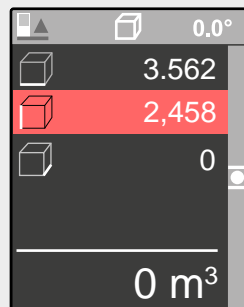
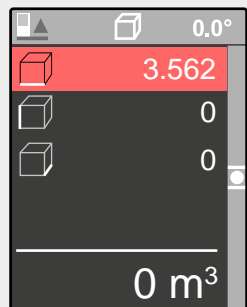
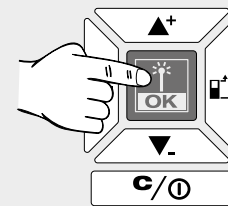
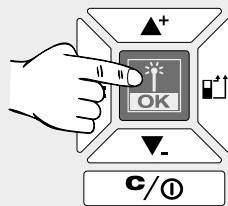
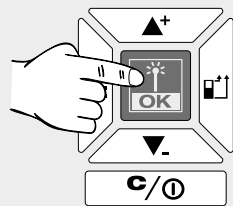

0

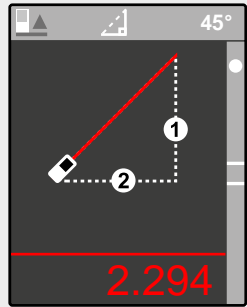

1

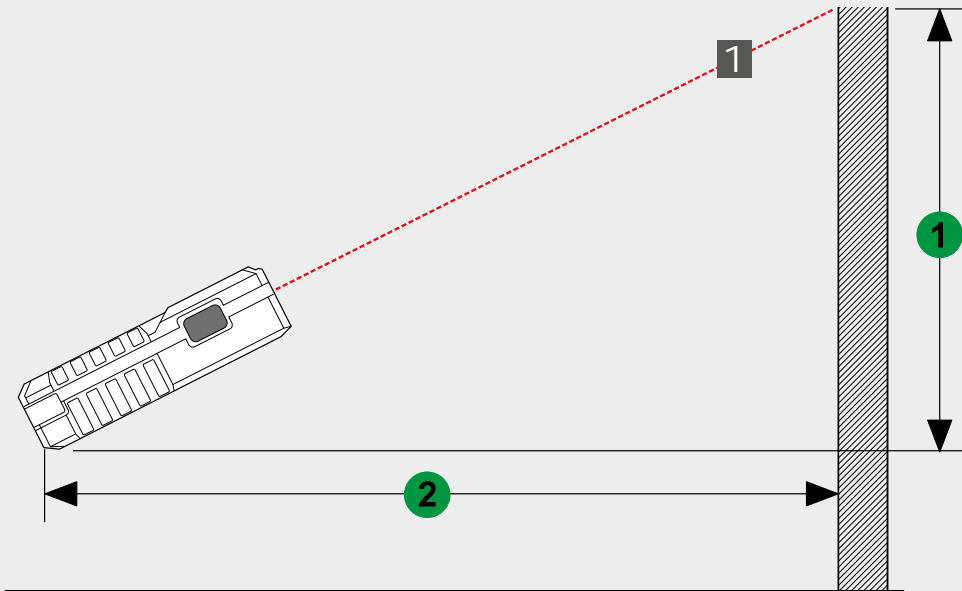
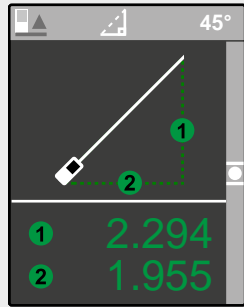
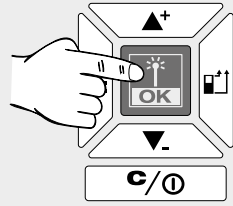



## MISURAZIONE INDIRETTA ALTEZZA (SOLO CON L'LDM 100)

0

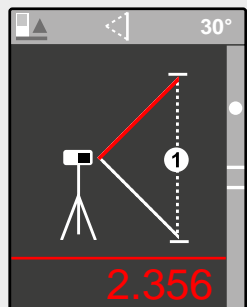

1

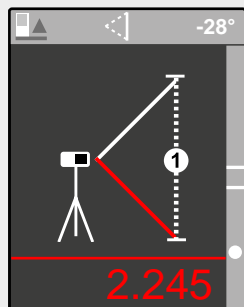
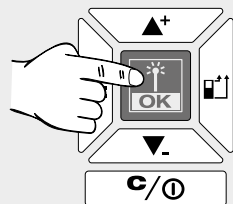

2

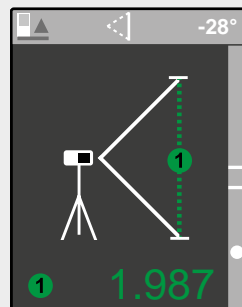
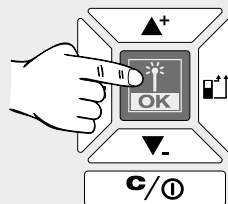

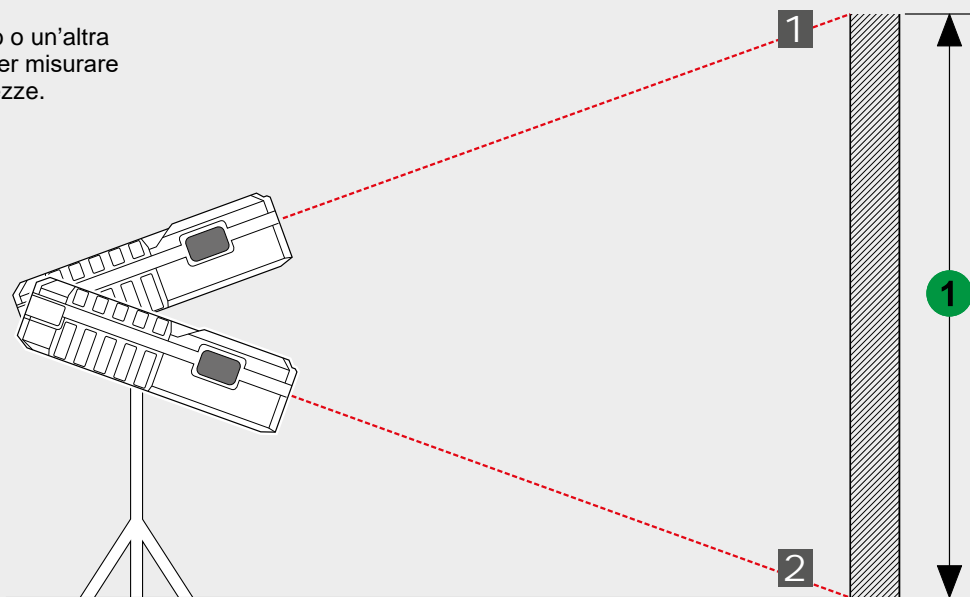

Usare un cavalletto o un'altra superficie stabile per misurare due diverse lunghezze.



## CONTENIDO

Instrucciones de seguridad importantes.....	1
Datos técnicos.....	2
Aplicación de acuerdo a la finalidad.....	2
Tabla de códigos de error.....	2
Resumen.....	3
Punto de medición.....	4
Menú.....	5
Iniciar.....	6
Medir la longitud.....	7
Medir la superficie.....	8
Medir la superficie total.....	9
Medir el volumen.....	10
Alturas indirectas / Nedición longitudinal (solo con LDM 100).....	11
Medición de alturas indirectas (solo con LDM 100).....	12

## INSTRUCCIONES DE SEGURIDAD IMPORTANTES

  Lea detenidamente las Instrucciones de seguridad y el Manual de empleo que se encuentran en el CD adjunto antes de empezar a trabajar con el producto.

### Clasificación de láser

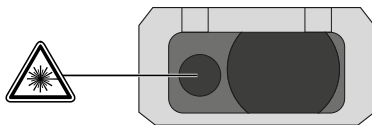

### ADVERTENCIA:

El producto corresponde a la Clase de láser 2 según la norma EN60825-1:2014



APARATO LÁSER PARA USUARIOS FINALES  
EN 50689:2021

### Advertencia:

Evite el contacto directo con los ojos. Debido a la intensa brillantez del rayo láser se puede producir un deslumbramiento durante un breve período de tiempo.

Absténgase de mirar directamente al rayo láser y no dirija éste a otras personas.

No deslumbrar intencionadamente a terceros.

### Advertencia:

No hacer funcionar el aparato láser cerca de niños o permitir a los niños que utilicen el aparato láser.

¡Atención! Una superficie reflectante podría dirigir el rayo láser de vuelta hacia el operador o hacia otra persona.

Respetar una distancia de seguridad de las partes móviles.

Realizar periódicamente mediciones de control. Especialmente cuando el producto ha estado sometido a esfuerzos excesivos así como antes y después de tareas de medición importantes.

Pueden producirse medidas erróneas si se utiliza un producto que esté defectuoso, después de haberse caído o haber sido objeto de transformaciones no permitidas.

**Advertencia:** El empleo de elementos de control, ajustes u operaciones diferentes a las especificadas en el manual podrían derivar en la exposición a una radiación peligrosa.

El aparato de medición por láser tiene un campo de aplicación limitado. (Véase capítulo Datos técnicos). Los intentos de medir fuera del rango máximo y mínimo ocasionan inexactitudes. El uso en condiciones meteorológicas adversas como por ejemplo demasiado calor, demasiado frío, luz solar brillante, lluvia, nieve, niebla u otras

condiciones que limitan la visión, pueden producir mediciones inexactas.

Si el aparato de medición por láser se lleva de un ambiente cálido a un ambiente frío (o al revés), espere hasta que el aparato se haya adaptado a la nueva temperatura ambiente

Guardar el aparato de medición por láser siempre en el interior de locales, proteger el aparato contra sacudidas y vibraciones o temperaturas extremas

Proteger el aparato de medición por láser siempre contra polvo, humedad y alta humedad del aire. Esto puede destruir los componentes internos o influir en la exactitud.

No utilice detergentes o disolventes agresivos. Limpiar solamente con un paño limpio y blando.

Evite golpes fuertes sobre el aparato de medición por láser o la caída del mismo. Se debería comprobar la exactitud del aparato, si éste se ha caído o si ha estado expuesto a otras cargas mecánicas.

Las reparaciones necesarias en este aparato láser deben ser realizadas únicamente por personal especializado y autorizado.

No utilizar el producto en áreas con una atmósfera potencialmente explosiva o volátil.

 Los residuos de pilas y de aparatos eléctricos y electrónicos no se deben desechar junto con la basura doméstica. Los residuos de pilas y de aparatos eléctricos y electrónicos se deben recoger y desechar por separado.

Retire los residuos de pilas y acumuladores, así como las fuentes de iluminación de los aparatos antes de desecharlos.

Infórmese en las autoridades locales o en su distribuidor especializado sobre los centros de reciclaje y los puntos de recogida. Dependiendo de las disposiciones locales al respecto, los distribuidores minoristas pueden estar obligados a aceptar de forma gratuita la devolución de residuos de pilas, aparatos eléctricos y electrónicos.

Contribuya mediante la reutilización y el reciclaje de sus residuos de pilas y de aparatos eléctricos y electrónicos a reducir la demanda de materias primas.

Los residuos de pilas (sobre todo de pilas de iones de litio) y de aparatos eléctricos y electrónicos contienen valiosos materiales reutilizables que pueden tener efectos negativos para el medio ambiente y su salud si no son desechados de forma respetuosa con el medio ambiente.

Antes de desecharlos, elimine los datos personales que podría haber en los residuos de sus aparatos.

 Marcado de conformidad europeo

 Marcado de conformidad británico

 Marcado de conformidad ucraniano

 Marcado de conformidad euroasiático

## DATOS TÉCNICOS

	LDM 45	LDM 100
Sistema óptico	15 mm x 9 mm	18 mm
Rango de medición		
Distancia mínima	0,05 m	0,05 m
Distancia máxima	45 m (Tolerancia: 45,1 m)	100 m (Tolerancia: 101 m)
Medición de distancia		
Tolerancia típica (válida para una reflectividad del objetivo del 100 % (pared pintada en blanco), baja iluminación de fondo, 25 °C)	± 2,0 mm (se debe tener en cuenta una tolerancia adicional de 0,1 mm/m)	± 2,0 mm (se debe tener en cuenta una tolerancia adicional de 0,1 mm/m)
Tolerancia máxima (válida para objetivos con menor reflectividad, un mayor nivel de iluminación de fondo o de temperaturas que se aproxime al valor inferior o superior)	± 4,0 mm (se debe tener en cuenta una tolerancia adicional de 0,15 mm/m)	± 4,0 mm (se debe tener en cuenta una tolerancia adicional de 0,15 mm/m)
Unidad más pequeña indicada	1,0 mm	1,0 mm
Tamaño del punto láser		
Distancia de 16 m:	25 x 50 mm	25 x 50 mm
Clase de láser	2	2
Tipo de láser	635 nm, < 1 mW	635 nm, < 1 mW
Ángulo vertical		
Ángulo vertical	+1 grado	+1 grado
Ángulo horizontal	±1 grado	±1 grado
Tipo de display	LCD (31,5 mm x 40 mm)	LCD (31,5 mm x 40 mm)
Desconexión automática del láser	90 segundos	90 segundos
Desconexión automática del aparato	180 segundos	180 segundos
Alimentación de corriente	AAA 2x (batería alcalina)	AAA 2x (batería alcalina)
Vida útil de la batería	8000 (medición individual)	8000 (medición individual)
Rosca de montaje de trípode	1/4"	1/4"
Rango de temperatura de trabajo	-0°C a +40°C	-0°C a +40°C
Rango de temperatura de almacenamiento	-10°C a +60°C	-10°C a +60°C
Peso sin batería	87 g	122 g
Clase de protección	IP54 (protegido contra el polvo y las salpicaduras de agua)	IP54 (protegido contra el polvo y las salpicaduras de agua)

## APLICACIÓN DE ACUERDO A LA FINALIDAD

El aparato de medición por láser es apropiado para la medición de distancias e inclinaciones. No utilice este producto para ninguna otra aplicación que no sea su uso normal.

## TABLA DE CÓDIGOS DE ERROR

Código	Descripción	Solución
Err500	Problemas de hardware	Apague el medidor y vuelva a encenderlo. Si el problema persiste, lleve el medidor de láser al centro de servicio técnico más próximo.

# RESUMEN

## BARRA DE ESTADO

- ▶ Punto de medición de referencia, tipo de medición, ángulo de medición (solo con LDM 100), plano de medición (solo con LDM 100)

## MONITOR

- ▶ Menú
- ▶ Mediciones
- ▶ Ajustes

## HACIA ARRIBA / SUMAR

- ▶ Desplazarse en el menú hacia arriba
- ▶ Sumar el valor

## MEDICIÓN / OK

- ▶ Encender el láser
- ▶ Guardar el valor medido
- ▶ Seleccionar OK en el menú

## MENÚ

- ▶ Proceso
- ▶ Medición
- ▶ Ajustes

## HACIA ABAJO / RESTAR

- ▶ Desplazarse en el menú hacia abajo
- ▶ Restar el valor

## BORRAR / ENCENDER / APAGAR

- ▶ ENCENDIDO / APAGADO (mantener pulsada la tecla hasta que el dispositivo emita una señal acústica)
- ▶ Borrar el valor medido

## PUNTO DE MEDICIÓN

- ▶ Atrás (ajuste estándar)
- ▶ Adelante
- ▶ Ángulo (se activa automáticamente al extender el perno)



## MEDIR

- ▶ Encender el láser
- ▶ Guardar el valor medido

## CAMBIAR LAS BATERÍAS

- ▶ Si parpadea el símbolo de batería, cambiar las baterías.

1

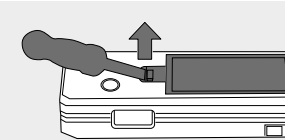

2

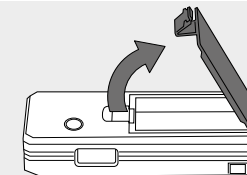

3

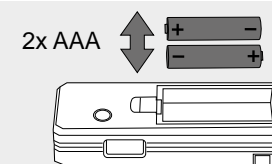

4

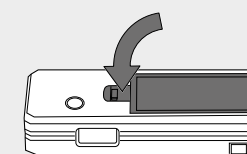

## TRÍPODE

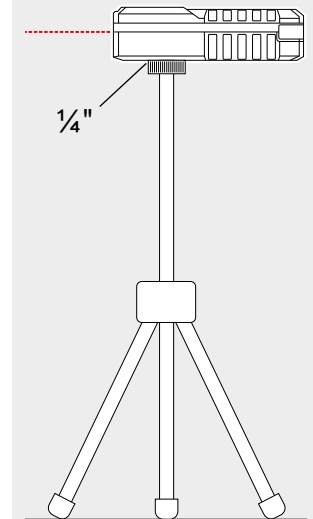

## PERNO ANGULAR

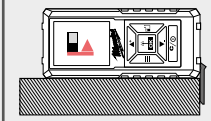
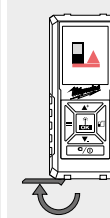
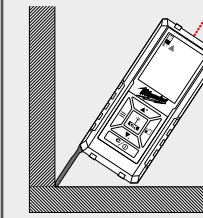

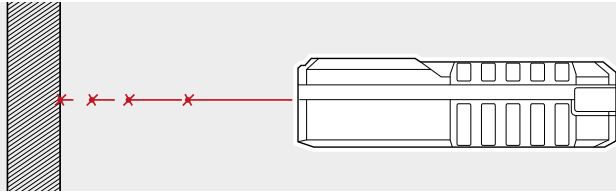

Durante la medición, el rayo láser parpadea de forma continua.

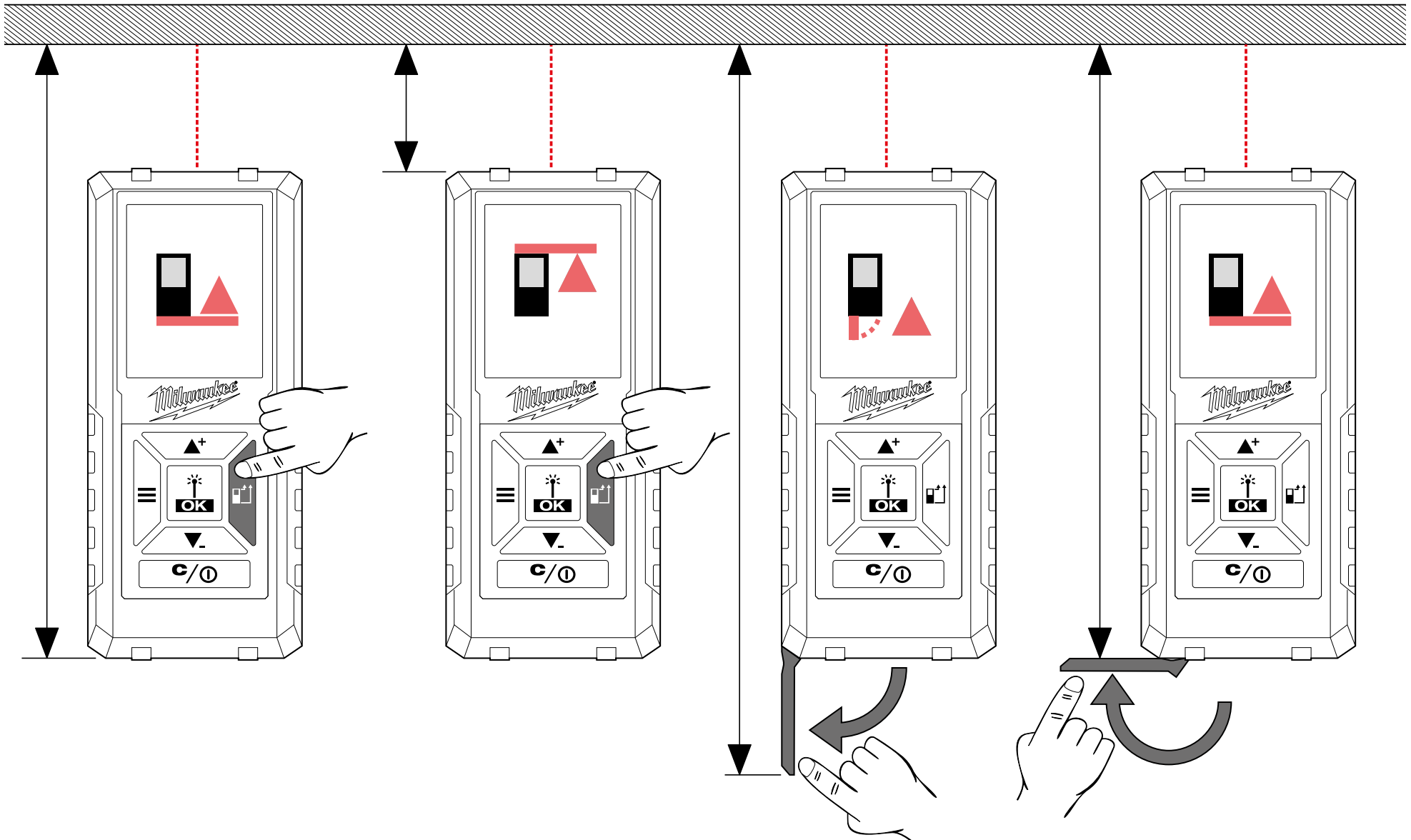

# MENÚ

## PROCESO



Visualización de las últimas 30 mediciones/cálculos.  
Las mediciones individuales para calcular la superficie, la superficie total, el volumen, etc., no se guardan en PROCESO, sino que solo se guarda el resultado de los cálculos.  
Para borrar una entrada de datos, pulse la tecla C/ENCENDIDO/APAGADO.

De los valores guardados en PROCESO se pueden sumar o restar mediciones o cálculos. Solo se pueden llevar a cabo cálculos del mismo tipo (longitud, superficie, volumen, etc.).

- Realización de un cálculo:
1. Utilizar las teclas ▲+ ▼- para seleccionar un modo de medición del PROCESO.
  2. Pulsar la tecla OK.
  3. Realizar las mediciones necesarias para el cálculo.
  4. Pulsar la tecla OK para guardar el nuevo cálculo en el PROCESO.

## MEDICIÓN

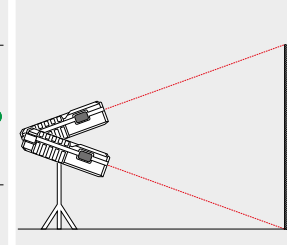
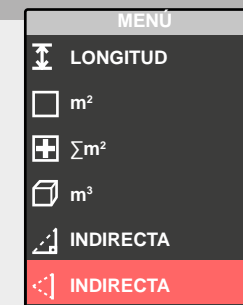
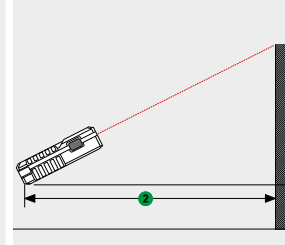
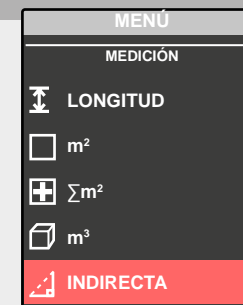
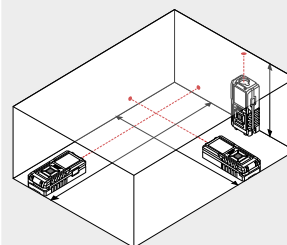
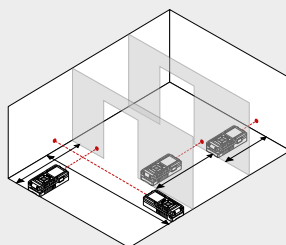
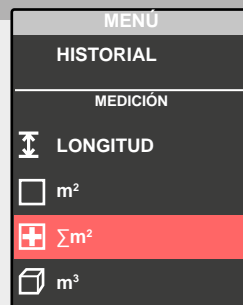
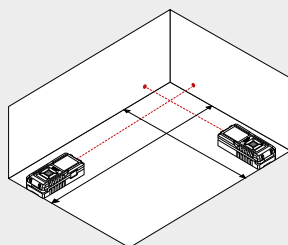
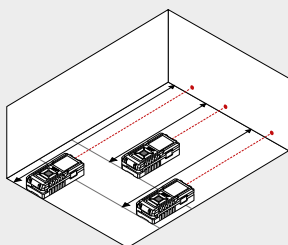

## AJUSTES



Elegir la unidad de medida deseada.







Señal acústica activada/desactivada.

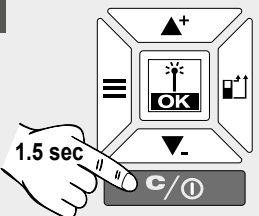
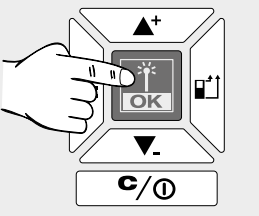
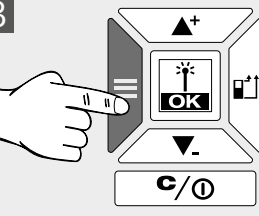
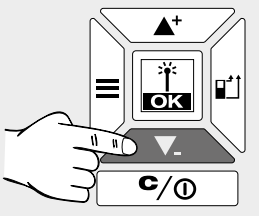
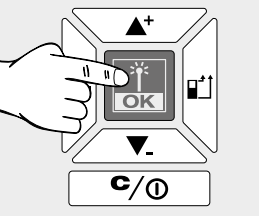

Elegir idioma.

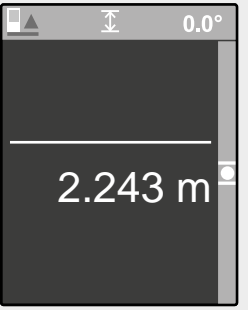
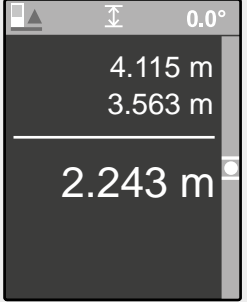
# INICIAR

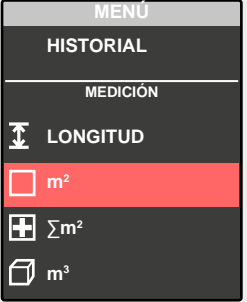
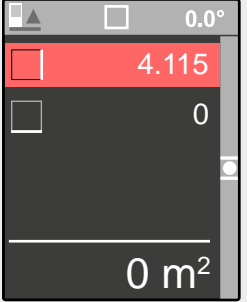
<p>1</p>  <p>1.5 sec</p>	<p>2</p> 	<p>3</p> 	<p>4</p> 	<p>5</p> 
 				
<p>Al encender se activa automáticamente el MODO DE MEDICIÓN LONGITUDINAL.</p>	<p>Realice una MEDICIÓN LONGITUDINAL, o bien....</p>	<p>... pulse la tecla de menú para cambiar al menú ...</p>	<p>... y elija otro modo operativo sirviéndose de las teclas ▲+ ▼- y ...</p>	<p>... y active dicho modo operativo pulsando la tecla OK.</p>

# MEDIR LA LONGITUD

0



Valor medido en blanco = se ha medido el valor

1

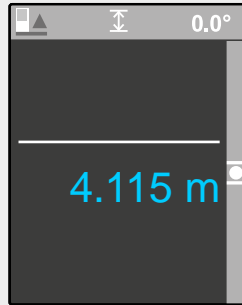
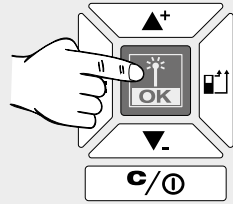

Valor medido en azul = se ha guardado el valor temporalmente

2

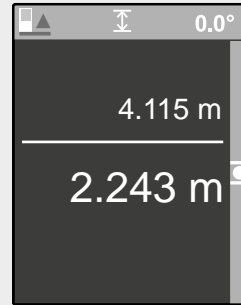
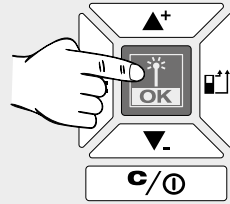

3

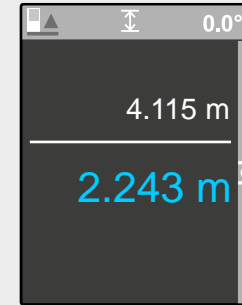
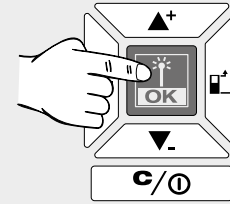

4

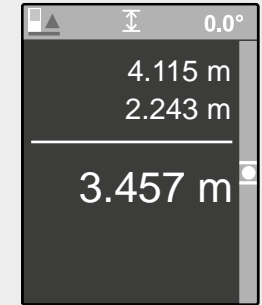
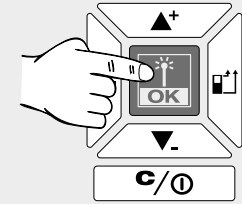

5

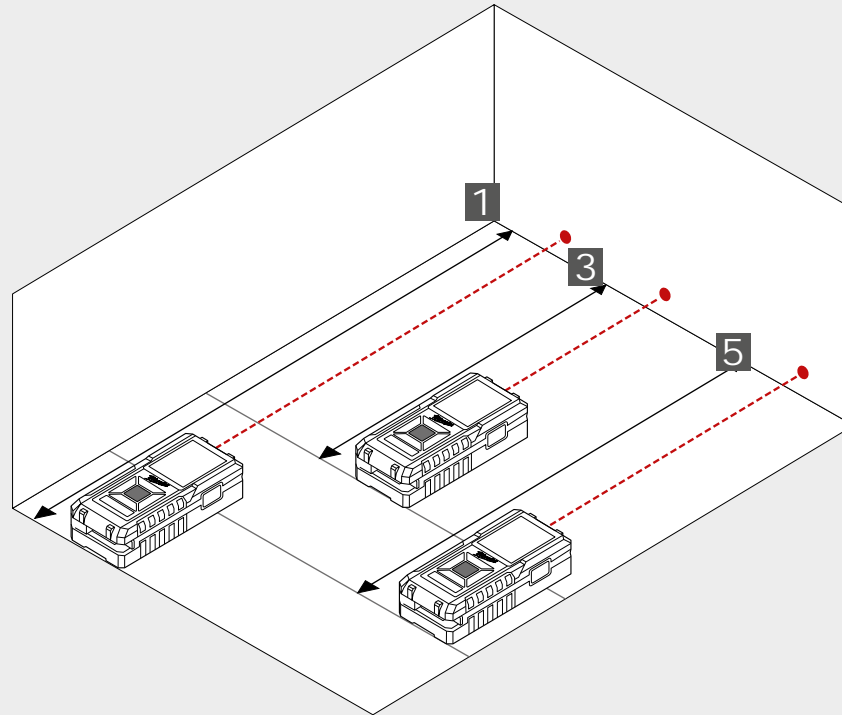
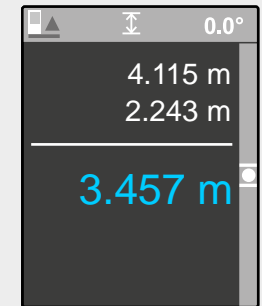
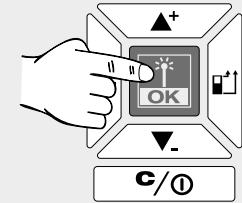



0

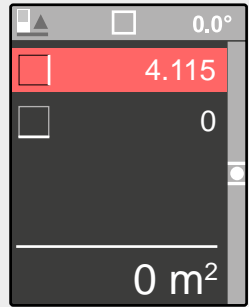

1

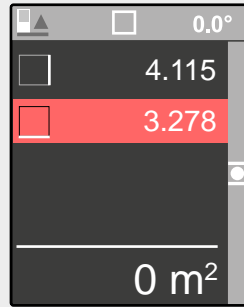
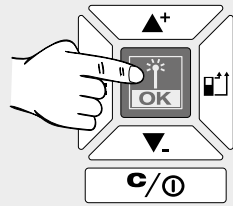

2

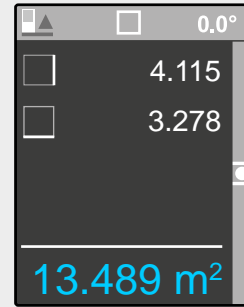
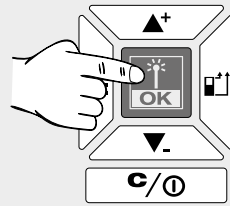

2

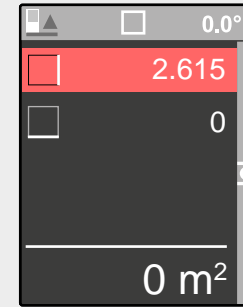
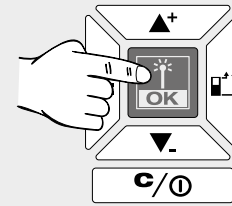

Nueva medición.  
El valor se guarda en PROCESO.

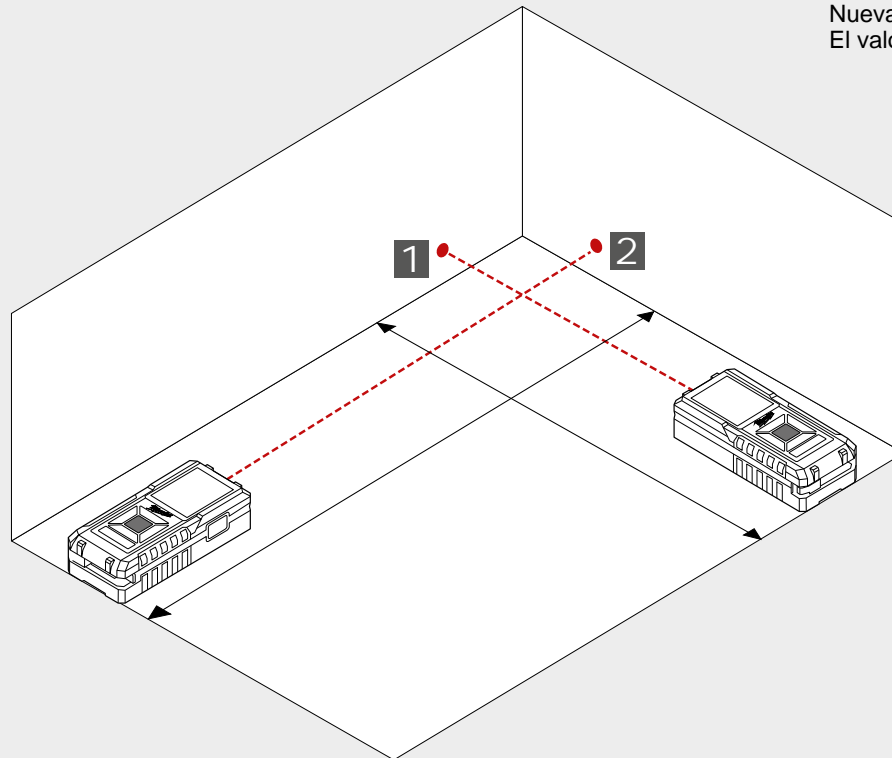

# MEDIR LA SUPERFICIE TOTAL

0

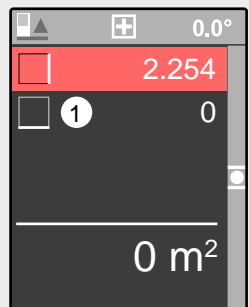

1

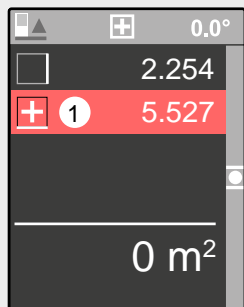
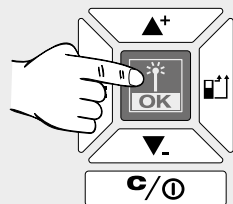

2

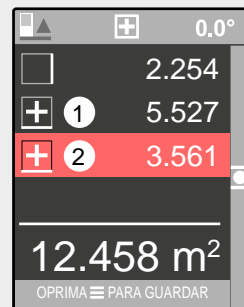
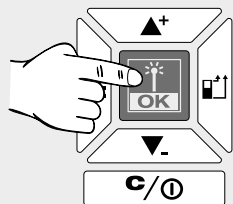

3

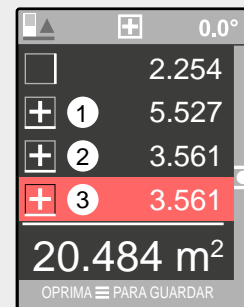
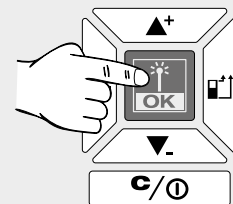

4

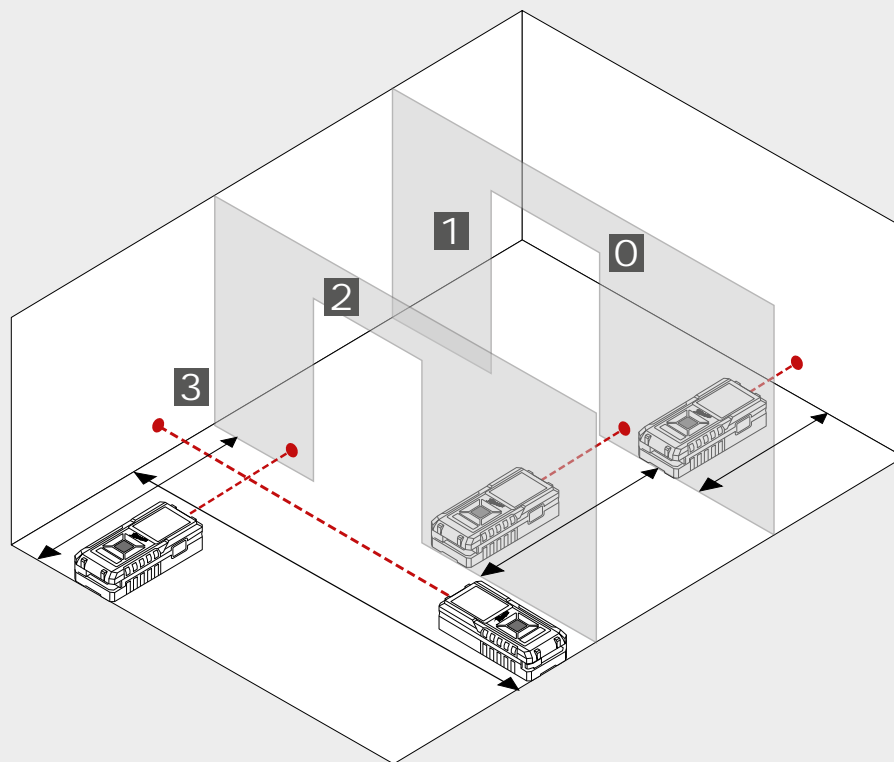
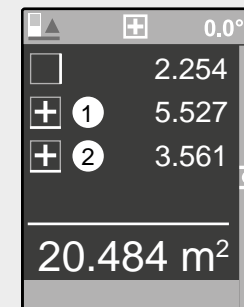
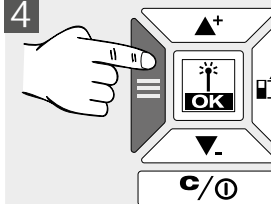

4

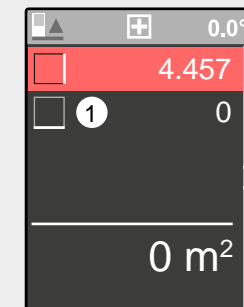
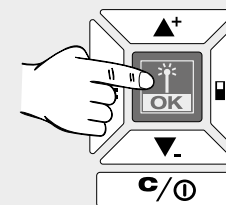

Nueva medición.  
El resultado se guarda en PROCESO.

0

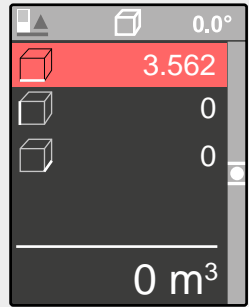

1

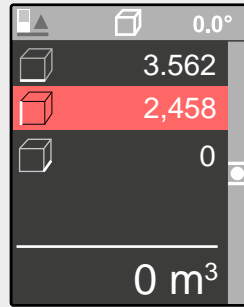
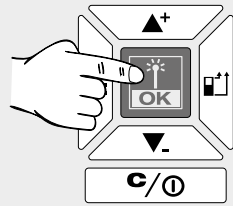

2

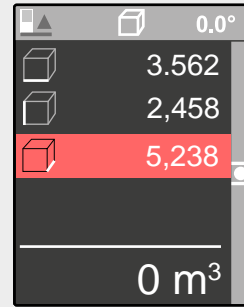
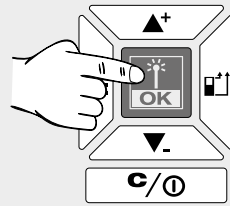

3

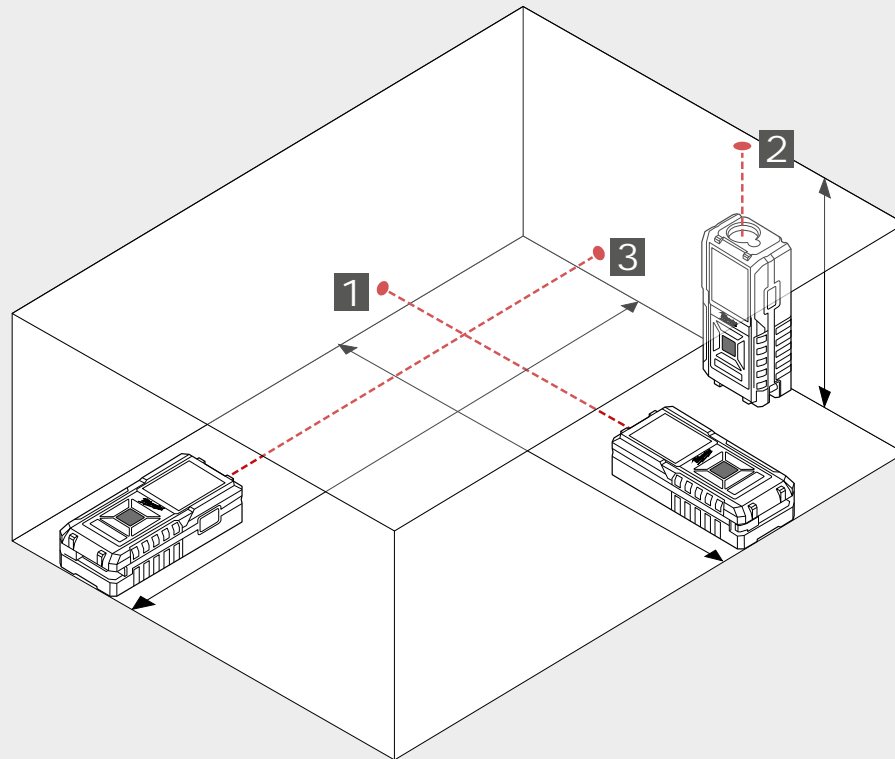
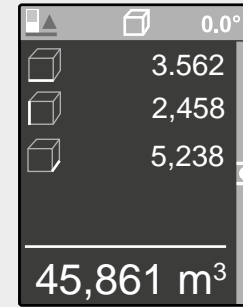
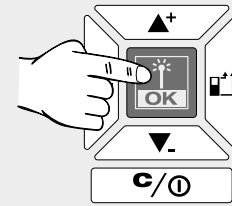

0

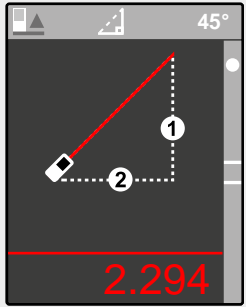

1

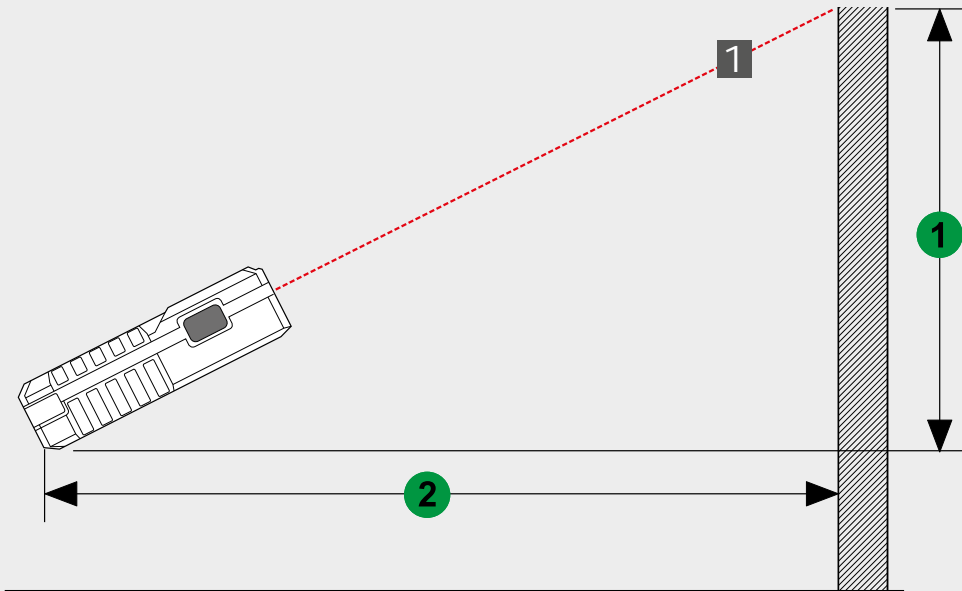
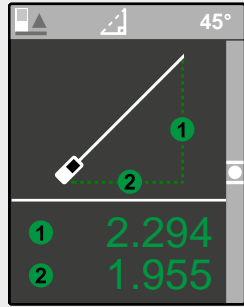
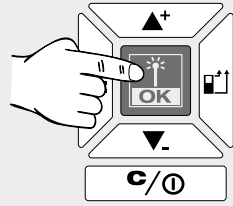

# MEDICIÓN DE ALTURAS INDIRECTAS (SOLO CON LDM 100)

0

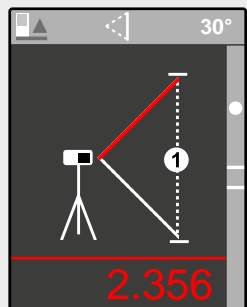

1

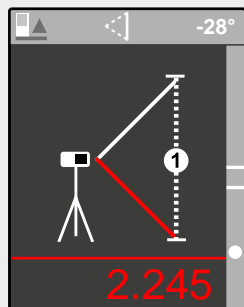
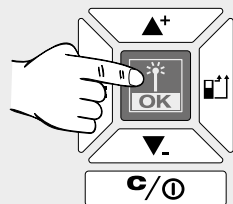

2

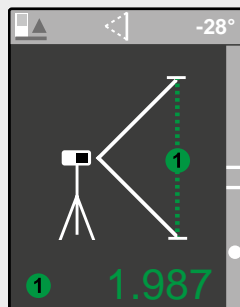
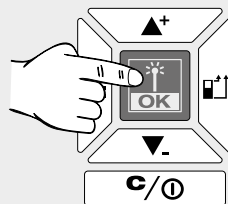

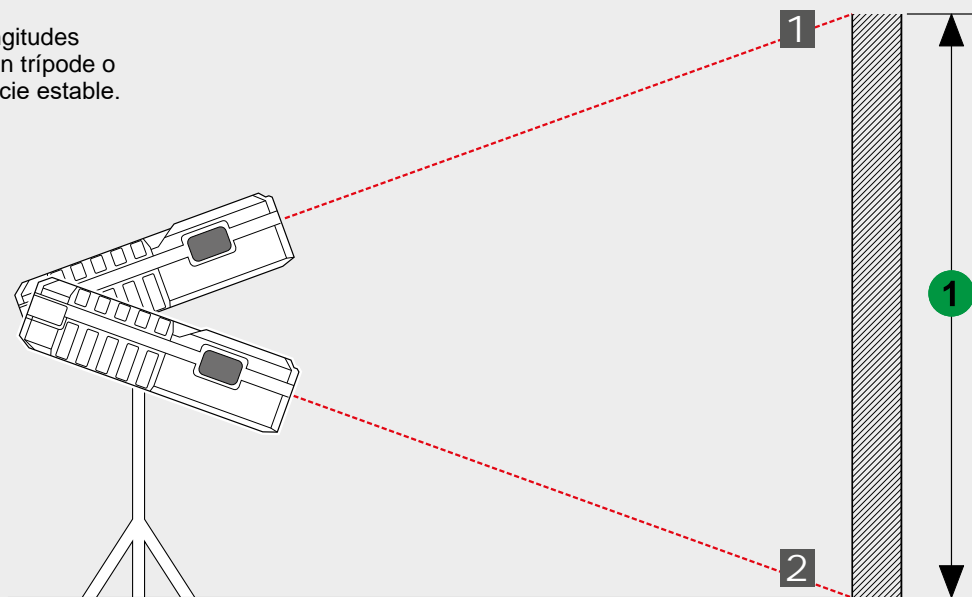

Para medir dos longitudes diferentes, utilice un trípode o alguna otra superficie estable.



## CONTEÚDO

Instruções de Segurança Importantes.....	1
Características técnicas .....	2
Utilização autorizada .....	2
Tabela de códigos de erro .....	2
Vista geral.....	3
Ponto de medição.....	4
Menu.....	5
Iniciar .....	6
Medir o comprimento.....	7
Medir a área .....	8
Medir a área total.....	9
Medir o volume.....	10
Medição de altura/comprimento indireta (só com LDM 100) 11	
Medição de altura indireta (só com LDM 100).....	12

## INSTRUÇÕES DE SEGURANÇA IMPORTANTES

  Não utilizar o produto, antes de ler atentamente as Instruções de Segurança e o Manual de Operação incluídos no CD-ROM fornecido com o produto.

### Classificação do laser

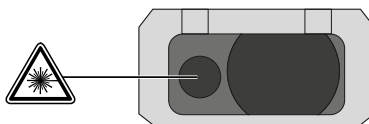

### ATENÇÃO:

Produto laser de Classe 2, de acordo com a Norma EN60825-1:2014



DISPOSITIVO LASER PARA UTILIZADORES FINAIS  
EN 50689:2021

### Aviso:

Não olhar directamente para o feixe de luz laser. O raio laser pode queimar os olhos e levar a uma cegueira temporária.

Não olhar directamente para o feixe de luz laser, nem apontar o feixe de luz directamente para as outras pessoas.

Não apontar o feixe de luz laser para outras pessoas.

### Aviso:

Não opere o aparelho de laser na proximidade de crianças e não deixe crianças usar o aparelho de laser.

Atenção! Uma superfície reflectora pode reflectar o raio laser ao operador ou a terceiros.

Manter as extremidades a uma distância segura das peças móveis.

Efectuar medições de teste frequentes. Especialmente, antes, durante ou depois de medições importantes.

Em caso de anomalia no funcionamento, queda ou utilização incorrecta do produto, ou se este tiver sido modificado, existe o risco de as medições efectuadas serem incorrectas.

**Aviso:** A utilização de elementos de controlo, ajustes ou a execução de processos não determinados no manual pode levar a uma exposição à radiação perigosa.

O medidor a laser tem uma área de utilização limitada. (Veja a secção Dados técnicos). Tentativas de medir fora da área máxima e mínima levam medições inexactas. A utilização em caso de condições adversas, como muito quente, muito frio, luz do sol muito clara, chuva, neve, névoa ou outras condições que prejudiquem a vista pode levar a medições inexactas.

Se o medidor a laser for levado de um ambiente quente a um ambiente frio (ou vice-versa), aguarde até o aparelho se adaptar à temperatura ambiente nova.

Guarde o medidor a laser no interior, proteja o aparelho contra choque, vibrações ou temperaturas extremas.

Proteja o medidor a laser contra pó, humidade e alta humidade do ar. Isto poderia destruir componentes internos ou influenciar a precisão.

Não use detergentes ou solventes agressivos. Só limpe com um pano limpo e macio.

Evite choques duros ou a queda do medidor a laser. A precisão do aparelho deve ser verificada depois dele cair ou ter sido exposto a outros esforços mecânicos.

Reparações necessárias neste aparelho de laser só devem ser executadas pelo pessoal especializado e autorizado.

Não utilizar o produto em áreas com risco de explosão ou ambientes agressivos.

 Resíduos de pilhas, resíduos de equipamentos eléctricos e electrónicos não devem ser descartados com o lixo doméstico. Resíduos de pilhas, resíduos de equipamentos eléctricos e electrónicos devem ser recolhidos e descartados separadamente.

Remova os resíduos de pilhas, os resíduos de acumuladores e as luzes antes de descartar os equipamentos.

Informe-se sobre os centros de reciclagem e os postos de coleta nas autoridades locais ou no seu vendedor autorizado.

Dependendo dos regulamentos locais, os retalhistas podem ser obrigados a retomar gratuitamente os resíduos de pilhas e os resíduos de equipamentos eléctricos e electrónicos.

Contribua a reduzir as necessidades de matérias-primas, reutilizando e reciclando os seus resíduos de pilhas e os seus resíduos de equipamentos eléctricos e electrónicos.

Resíduos de pilhas (particularmente pilhas de ion lítio), resíduos de equipamentos eléctricos e electrónicos contêm materiais valiosos e reutilizáveis que podem ter efeitos negativos para o meio ambiente e a sua saúde.

Apague eventuais dados pessoais existentes no seu resíduo de equipamento antes de descartá-lo.

 Marca de conformidade europeia

 Marca de conformidade britânica

 Marca de Conformidade Ucraniana

 Marca de Conformidade Eurasiática

## CARACTERÍSTICAS TÉCNICAS

	LDM 45	LDM 100
Lente	15 mm x 9 mm	18 mm
Gama de medição		
Distância mínima	0,05 m	0,05 m
Distância máxima	45 m (Tolerância: 45,1 m)	100 m (Tolerância: 101 m)
Medição de distância		
Tolerância típica (aplica-se à reflexão do alvo 100 % (parede pintada em branco), baixa iluminação do fundo, 25 °C)	± 2,0 mm (uma tolerância suplementar de 0,1 mm/m deve ser considerada)	± 2,0 mm (uma tolerância suplementar de 0,1 mm/m deve ser considerada)
Tolerância máxima (aplica-se a alvos com pequena reflexão, alta iluminação de fundo ou temperaturas que se aproximam ao valor inferior/superior)	± 4,0 mm (uma tolerância suplementar de 0,15 mm/m deve ser considerada)	± 4,0 mm (uma tolerância suplementar de 0,15 mm/m deve ser considerada)
Menor unidade indicada	1,0 mm	1,0 mm
Tamanho do ponto de laser		
Distância de 16 m:	25 x 50 mm	25 x 50 mm
Classe de laser	2r	2r
Tipo de laser	635 nm, < 1 mW	635 nm, < 1 mW
Raio laser		
ângulo vertical	+1 grau	+1 grau
ângulo horizontal	±1 grau	±1 grau
Tela tipo	LCD (31,5 mm x 40 mm)	LCD (31,5 mm x 40 mm)
Desligamento automático do laser	90 segundos	90 segundos
Desligamento automático do aparelho	180 segundos	180 segundos
Alimentação eléctrica	AAA 2x (bateria alcalina)	AAA 2x (bateria alcalina)
Vida útil da bateria	8000 (medição individual)	8000 (medição individual)
Rosca do tripé	1/4"	1/4"
Gama de temperatura de trabalho	-0°C a +40°C	-0°C a +40°C
Gama de temperatura de armazenamento	-10°C a +60°C	-10°C a +60°C
Peso sem bateria	87 g	122 g
Classe de protecção	IP54 (protegido contra pó e salpicos de água)	IP54 (protegido contra pó e salpicos de água)

## UTILIZAÇÃO AUTORIZADA

O medidor a laser destina-se a medir distâncias e inclinações.

Não use este produto de outra maneira sem ser a normal para o qual foi concebido.

## TABELA DE CÓDIGOS DE ERRO

Código	Descrição	Solução
Err500	Problemas de hardware	Desligue e ligue novamente o aparelho de medição. Se o problema perdurar, leve o aparelho de medição à central de assistência mais próxima.

## VISTA GERAL

### BARRA DE STATUS

- ▶ Ponto de medição de referência, tipo de medição, ângulo de medição (só com LDM 100), nível de medição (só com LDM 100)

### TELA

- ▶ Menu
- ▶ Medições
- ▶ Configuração

### PARA CIMA / ADICIONAR

- ▶ Ir para cima no menu
- ▶ Adicionar o valor

### MEDIÇÃO / OK

- ▶ Ligar o laser
- ▶ Memorizar o valor de medição
- ▶ Selecionar OK no menu

### MENU

- ▶ Histórico
- ▶ Medição
- ▶ Configuração

### PARA BAIXO / SUBTRAIR

- ▶ Ir para baixo no menu
- ▶ Subtrair o valor

### APAGAR / LIGAR / DESLIGAR

- ▶ LIGAR / DESLIGAR (mantenha a tecla pressionada até o aparelho emitir um sinal sonoro)
- ▶ Apagar o valor de medição

### PONTO DE MEDIÇÃO

- ▶ Atrás (ajuste padrão)
- ▶ Na frente
- ▶ Canto (é ativado automaticamente, desdobrando o pino)

### MEDIR

- ▶ Ligar o laser
- ▶ Memorizar o valor de medição

### TROCAR AS BATERIAS

- ▶ Troque as baterias quando o símbolo da bateria piscar.

1

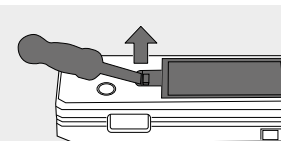

2

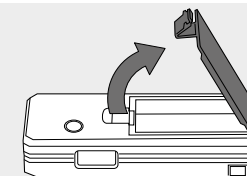

3

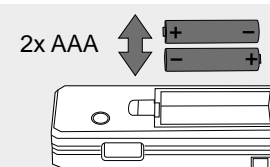

4

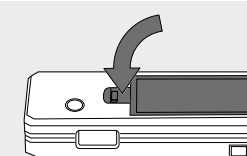

### TRIPÉ

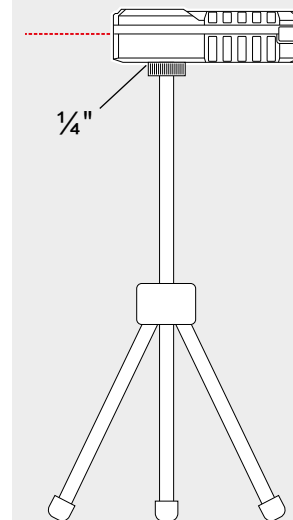

### PINO DE CANTO

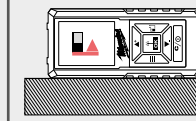
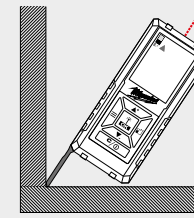



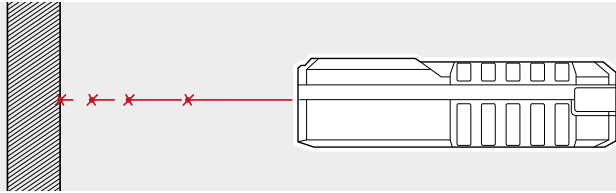

O raio laser pisca continuamente durante a medição.

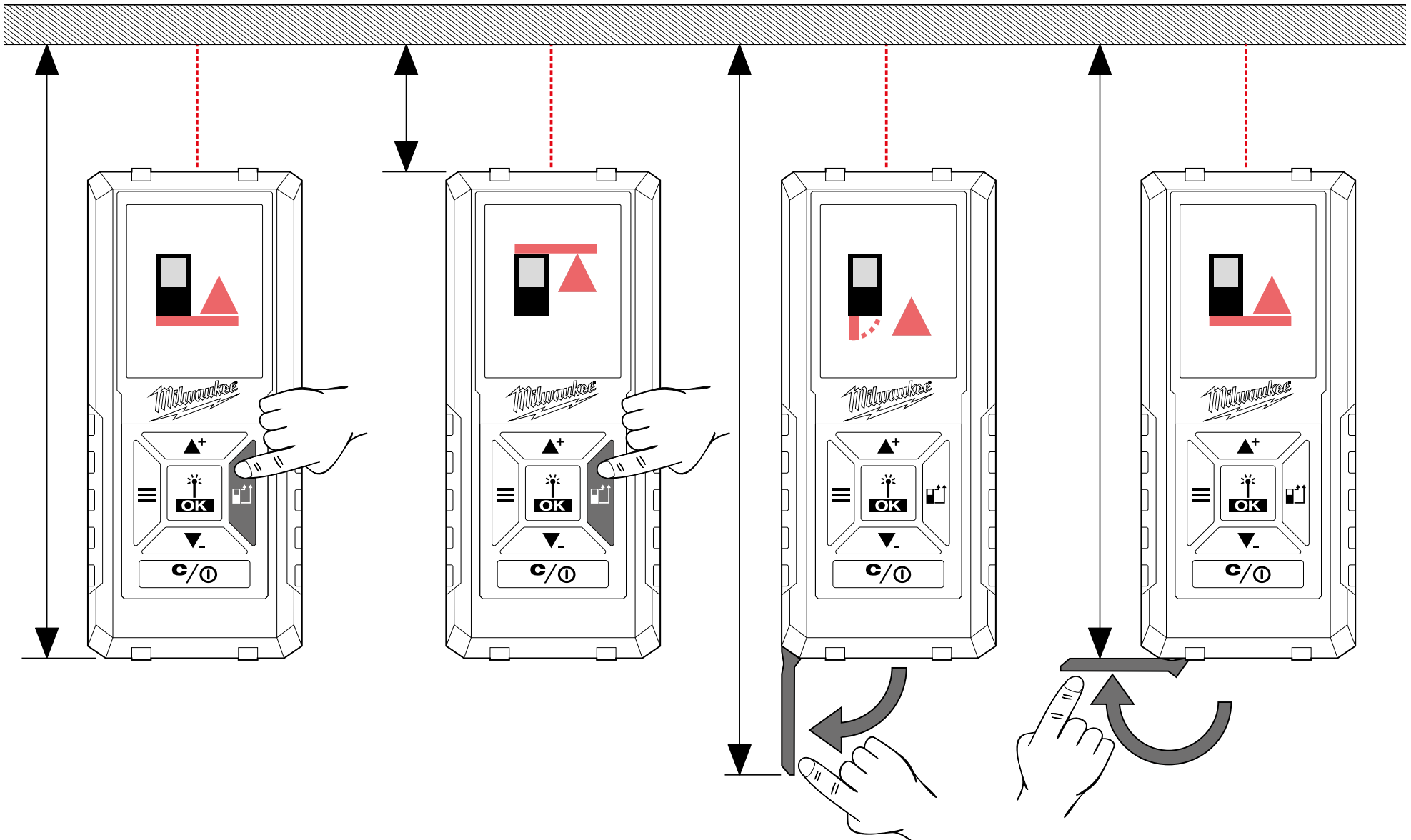

# MENU

## HISTÓRICO



Indicação das últimas 30 medições/cálculos. As medições individuais para o cálculo da superfície, da área total, do volume, etc., não são memorizadas no HISTÓRICO. Só é memorizado o resultado dos cálculos.

Para apagar um registo, pressione a tecla C/ LIGAR/DESLIGAR.

Medições/cálculos podem ser adicionados ou subtraídos dos valores memorizados no HISTÓRICO. Só podem ser executados cálculos do mesmo tipo (comprimento, área, volume, etc.).

Execução de um cálculo:

1. Use as teclas ▲+ ▼- para selecionar um modo de medição do HISTÓRICO.
2. Pressione a tecla OK.
3. Faça as medições necessárias para o cálculo.
4. Pressione a tecla OK para memorizar o cálculo novo no HISTÓRICO.

## MEDIÇÃO

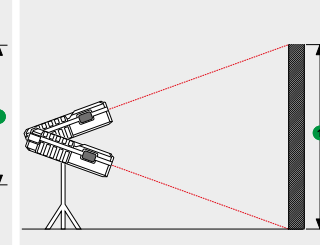
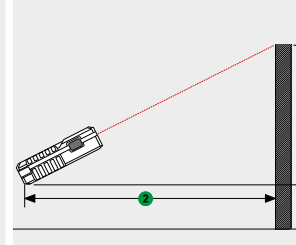
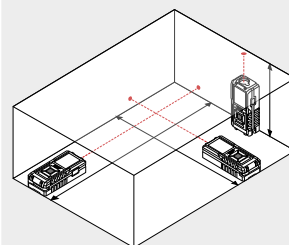
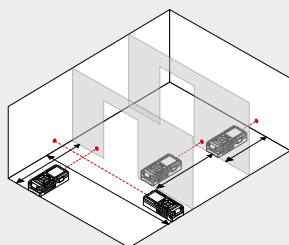
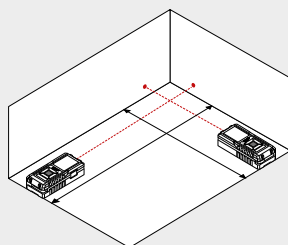
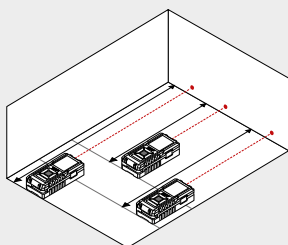
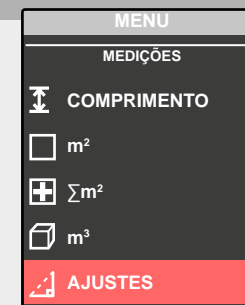

## CONFIGURAÇÃO



Selecione a unidade de medição desejada.

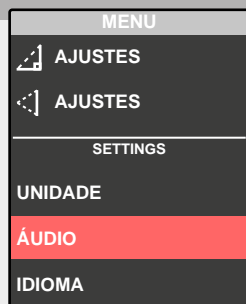



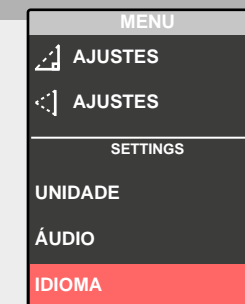

Ligar/Desligar o sinal sonoro.



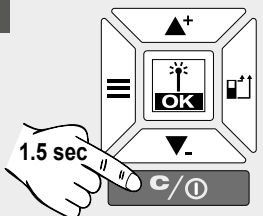
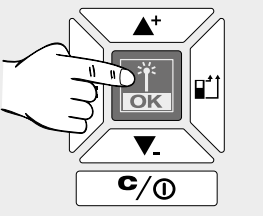
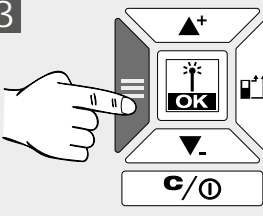
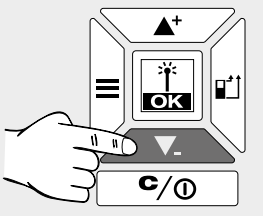
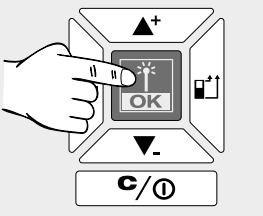

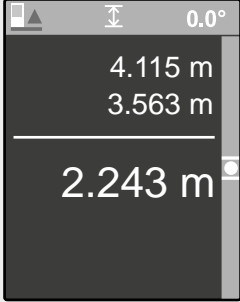
Selecione o idioma.

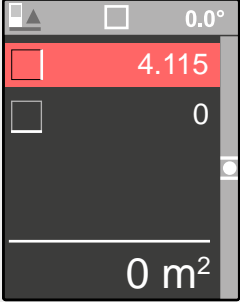
# INICIAR

<p>1</p>  <p>1.5 sec</p>	<p>2</p> 	<p>3</p> 	<p>4</p> 	<p>5</p> 
 				
<p>Depois de ligar, o MODO DE MEDIÇÃO DO COMPRIMENTO é ativado automaticamente.</p>	<p>Execute uma MEDIÇÃO DO COMPRIMENTO ou ...</p>	<p>... pressione a tecla do menu para ir ao menu ...</p>	<p>... e selecione outro modo de operação com as teclas ▲+ ▼- e ...</p>	<p>... e ative este modo de operação, pressionando a tecla OK.</p>

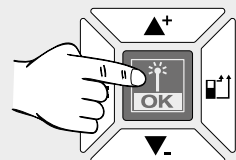
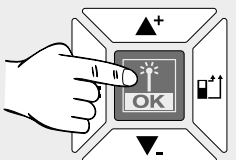
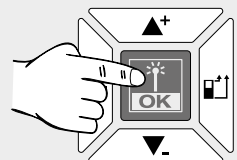
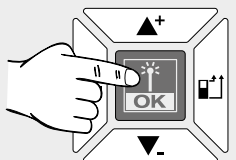
# MEDIR O COMPRIMENTO

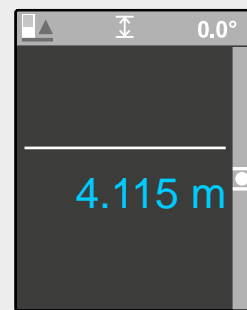
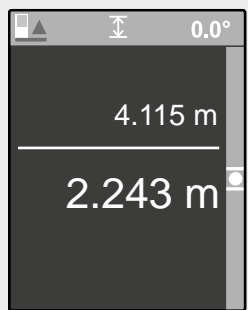
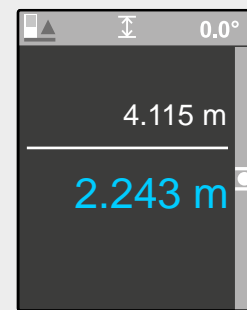
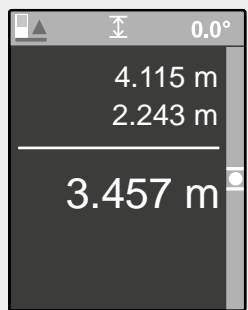
0	1 	2 	3 	4 
 <p>Valor de medição branco = Valor medido</p>	 <p>Valor de medição azul = Valor na memória intermediária</p>			

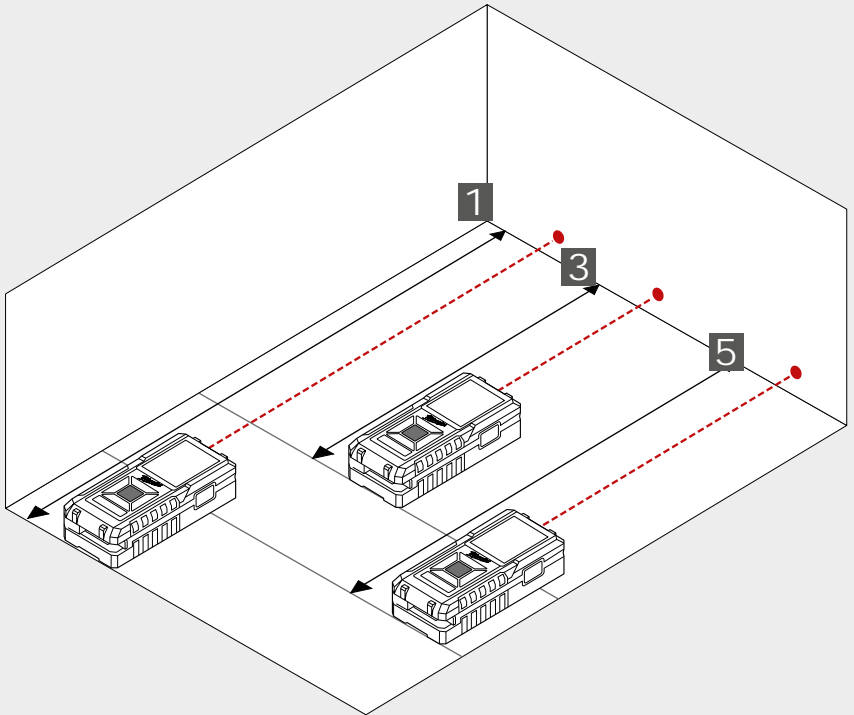
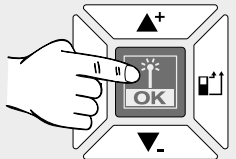
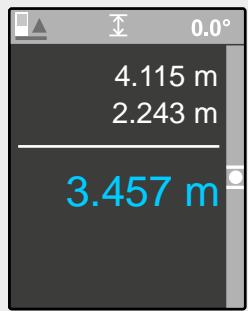
	5  
---	--

0

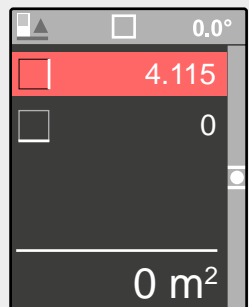

1

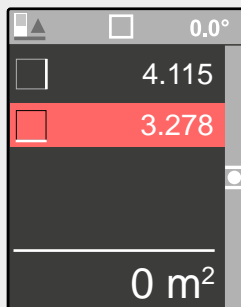
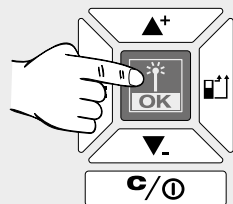

2

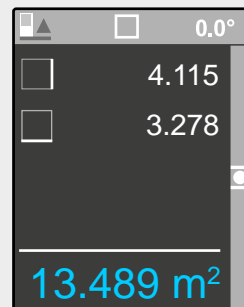
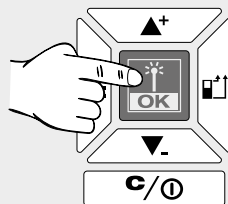

2

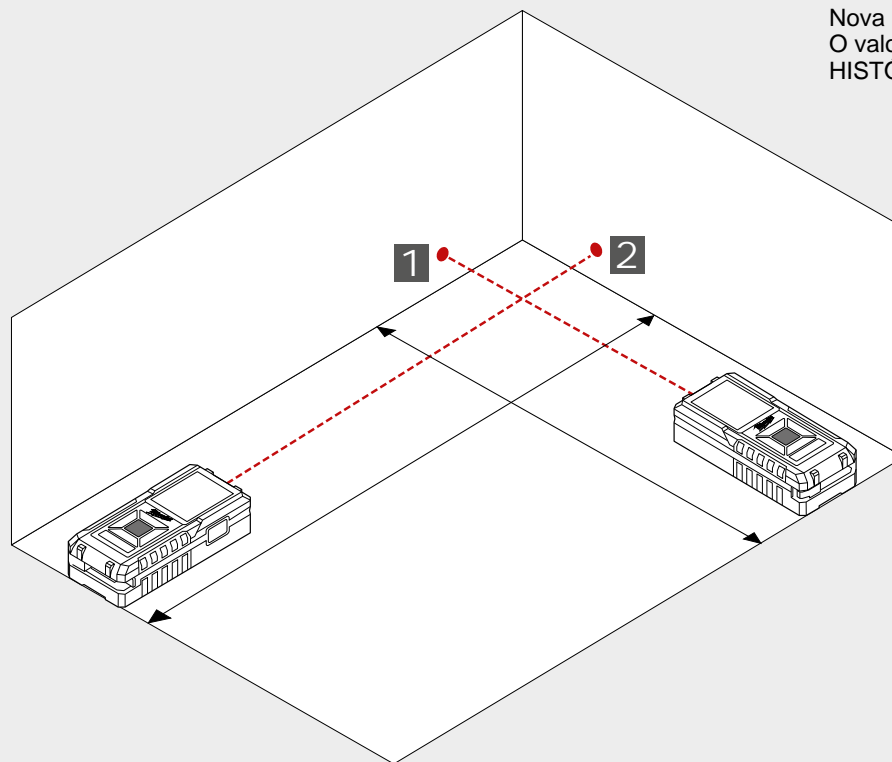
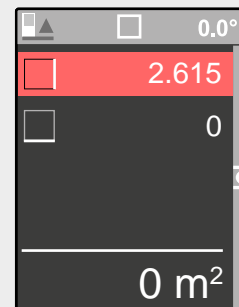
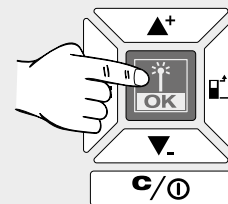

Nova medição.  
O valor é memorizado no  
HISTÓRICO.

# MEDIR A ÁREA TOTAL

0

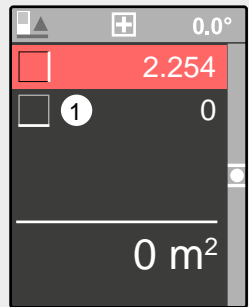

1

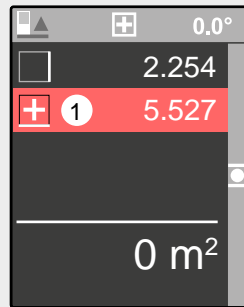
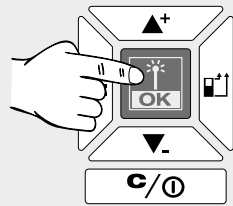

2

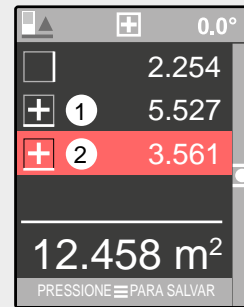
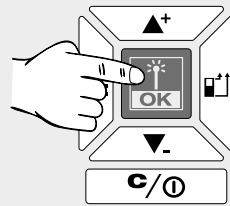

3

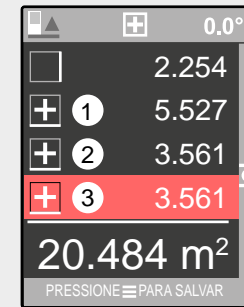
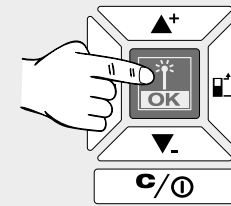

4

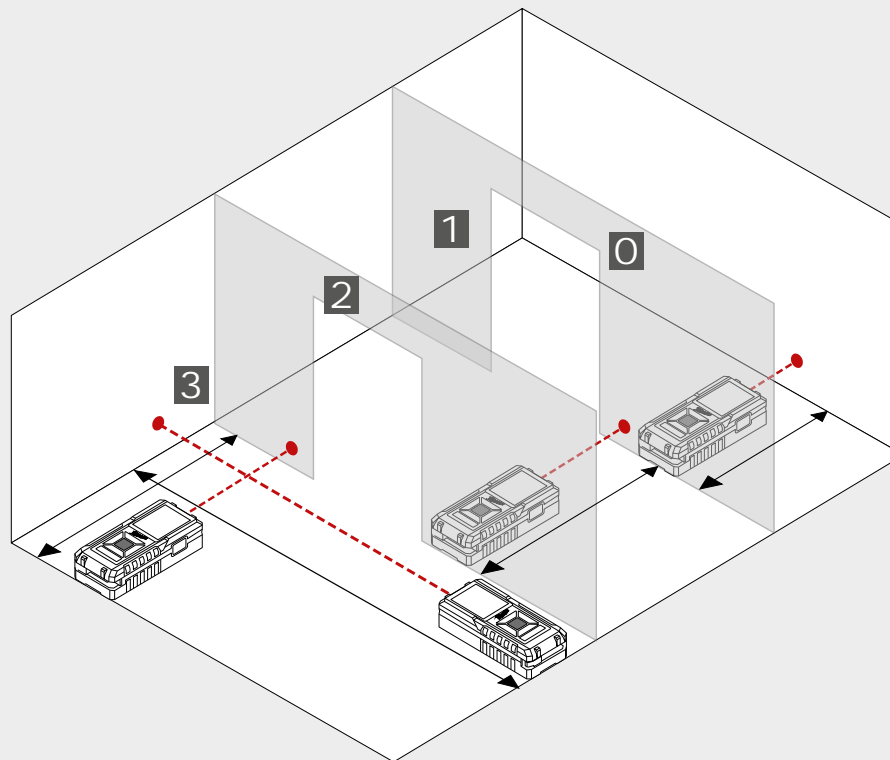
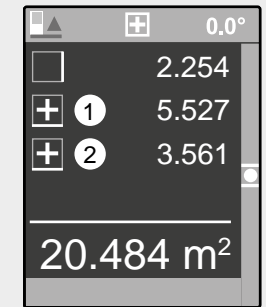
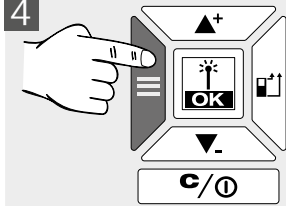

4

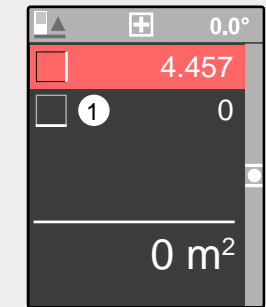
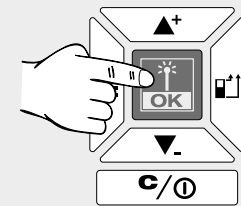

Nova medição.  
O resultado é memorizado no HISTÓRICO.

0

1

2

3

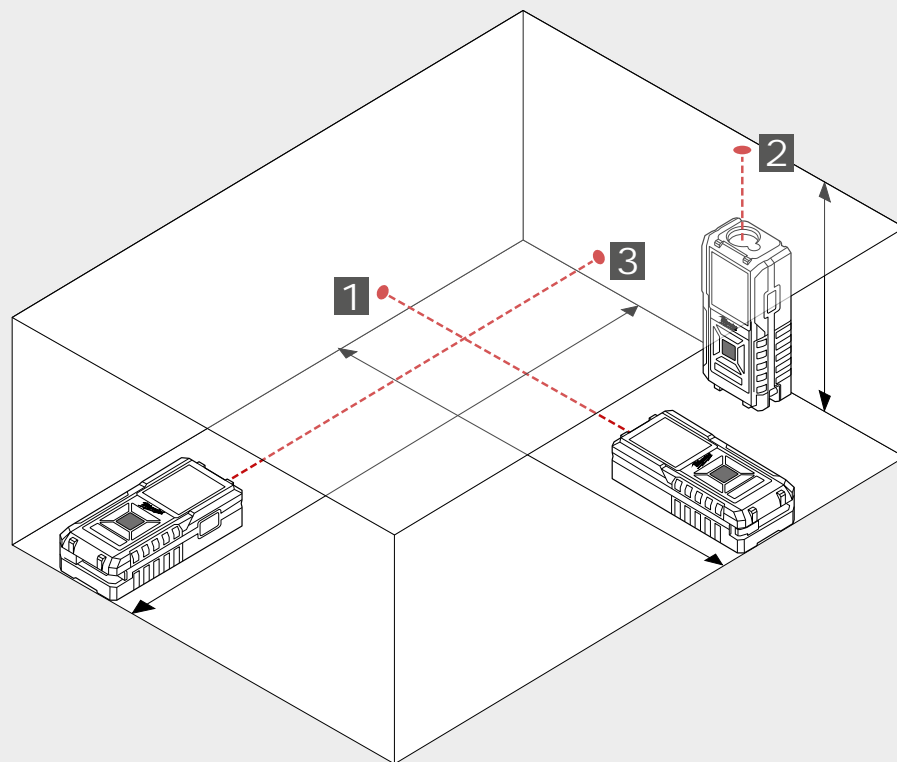
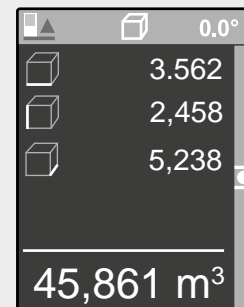
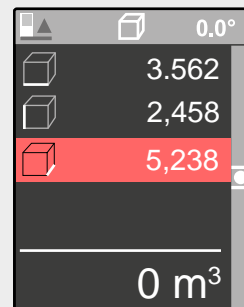
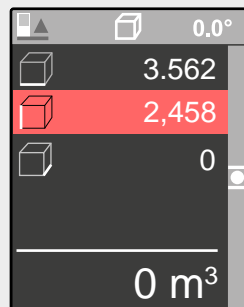
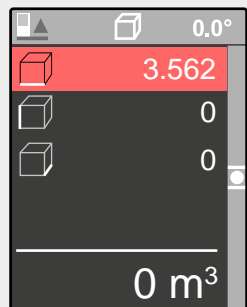
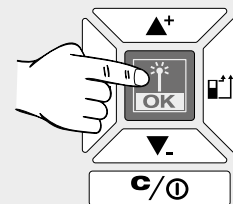
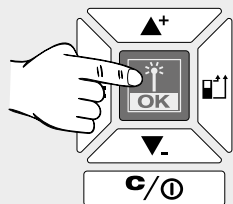
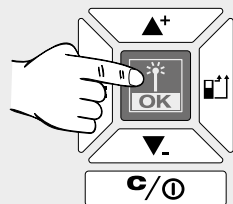

# MEDIÇÃO DE ALTURA/COMPRIIMENTO INDIRETA (SÓ COM LDM 100)

0

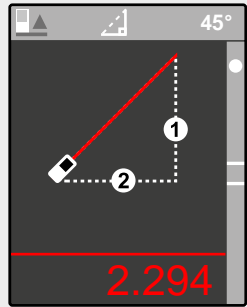

1

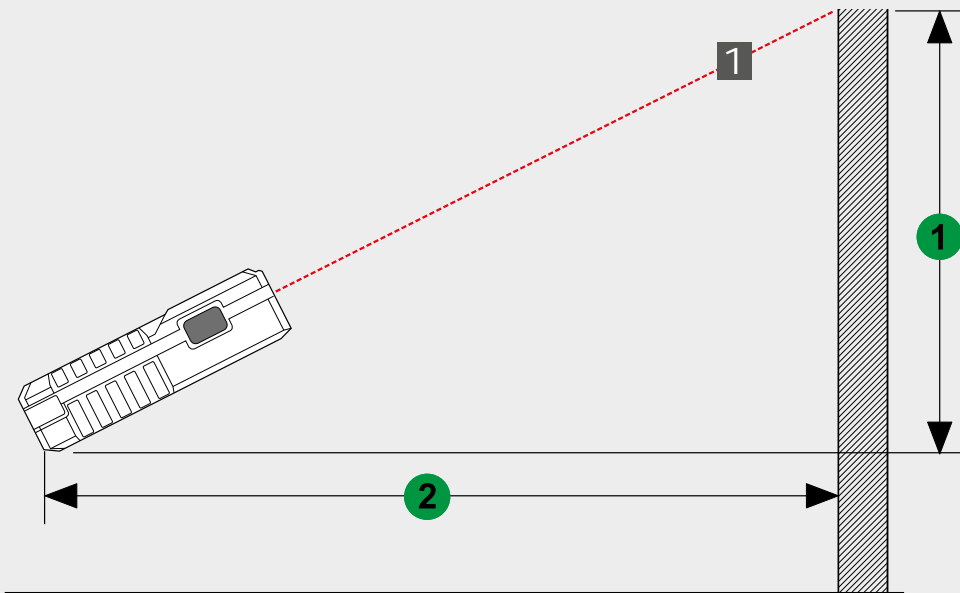
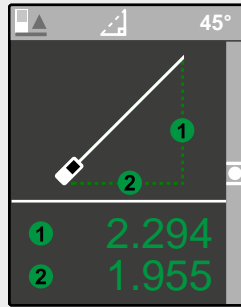
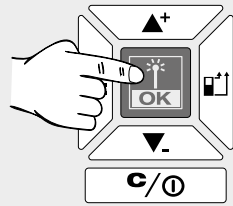



# MEDIÇÃO DE ALTURA INDIRETA (SÓ COM LDM 100)

0

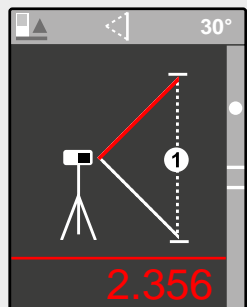

1

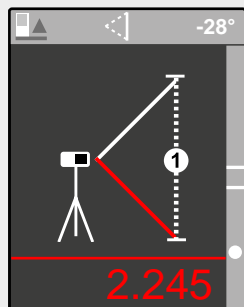
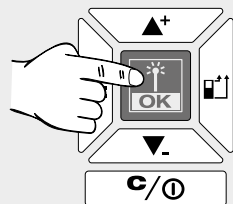

2

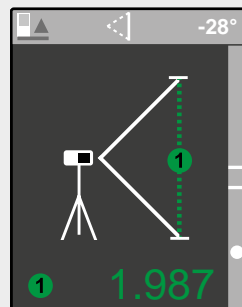
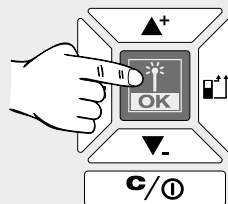

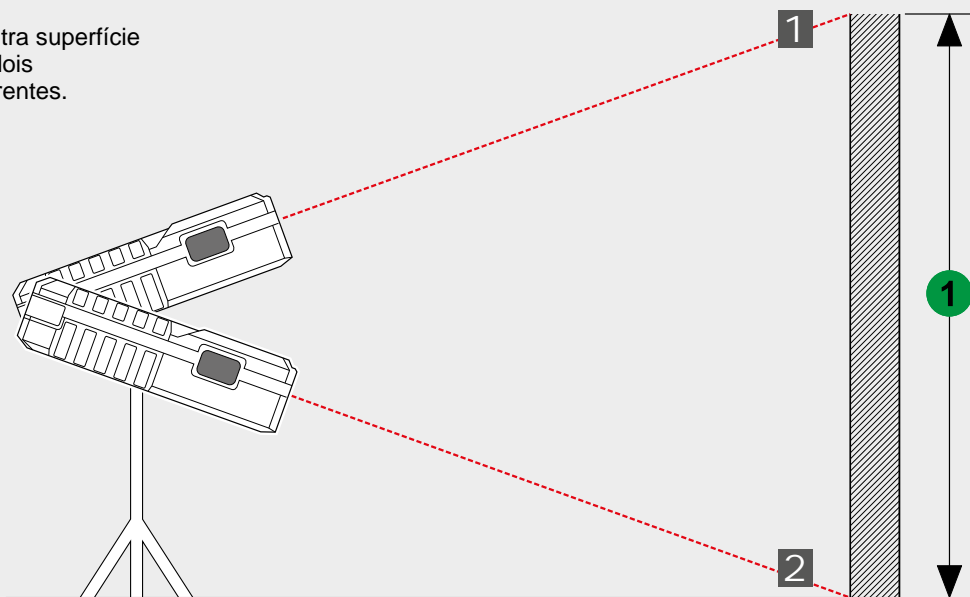

Use um tripé ou outra superfície sólida para medir dois comprimentos diferentes.



## INHOUD

Belangrijke Veiligheidsvoorschriften .....	1
Technische gegevens .....	2
Voorgeschreven gebruik van het systeem.....	2
Tabel met storingscodes.....	2
Overzicht .....	3
Meetpunt.....	4
Menu.....	5
Starten .....	6
Lengte meten.....	7
Oppervlak meten .....	8
Totaal oppervlak meten .....	9
Volume meten.....	10
Indirecte hoogte-/lengtemeting (alleen met LDM 100) .....	11
Indirecte hoogtemeting (alleen met LDM 100) .....	12

## BELANGRIJKE VEILIGHEIDSVOORSCHRIFTEN

  Gebruik dit product niet voordat u de veiligheidsinstructies en de gebruiksaanwijzing op de bijgevoegde CD hebt bestudeerd.

### Laserclassificatie

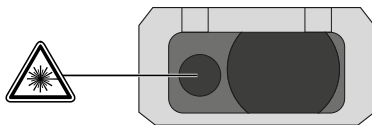

### WAARSCHUWING:

Het is een Klasse 2 laserproduct in overeenstemming met EN60825-1:2014



LASERTOESTEL VOOR EINDVERBRUIKERS  
EN 50689:2021

### Waarschuwing!

Vermijd direct blikcontact. Het felle licht van de laserstraal kan tot letsel aan de ogen leiden en de ogen kortstondig verblinden.

Kijk niet in de laserstraal en richt niet onnodig op andere personen.

Andere personen niet verblinden.

### Waarschuwing!

Het laserapparaat mag noch in de buurt van kinderen worden gebruikt noch mogen kinderen het apparaat gebruiken.

Opgelet! Een reflecterend oppervlak zou de laserstraal terug naar de bediener of een andere persoon kunnen reflecteren.

Houd een veilige afstand aan naar bewegende delen.

Verricht periodiek controlemetingen. Met name vlak voor, tijdens en na belangrijke metingen.

Pas op voor meetfouten als het instrument defect is of als het is gevallen, misbruikt of gemodificeerd.

**Waarschuwing!** Het gebruik van sturelementen of instellingen of de uitvoering van andere dan in de handleiding voorgeschreven processen kan leiden tot een gevaarlijke stralingsbelasting.

Het lasermeettoestel heeft een beperkt toepassingsbereik. (Zie hoofdstuk 'Technische gegevens'). Pogingen om buiten het maximale en minimale bereik te meten resulteren in onnauwkeurige resultaten. De toepassing onder ongunstige omstandigheden, zoals te grote hitte of koude, fel zonlicht, regen, sneeuw, mist of andere, het zicht belemmerende omstandigheden kan leiden tot onnauwkeurige meetresultaten.

Als het lasermeettoestel van een warme naar een koude omgeving wordt gebracht (of omgekeerd), moet u even wachten totdat het

toestel zich aan de nieuwe omgevingstemperatuur heeft kunnen aanpassen.

Bewaar het lasermeettoestel altijd in gesloten ruimten en bescherm het tegen schokken, vibraties of extreme temperaturen.

Bescherm het lasermeettoestel tegen stof, natheid en te hoge luchtvochtigheid. Deze factoren zouden inwendige onderdelen onherstelbaar kunnen beschadigen of de nauwkeurigheid negatief kunnen beïnvloeden.

Gebruik geen agressieve reinigingsmiddelen of oplosmiddelen. Reinig het toestel uitsluitend met een schone, zachte doek.

Voorkom harde stoten en laat het toestel niet vallen. De nauwkeurigheid van het toestel dient te worden gecontroleerd als het gevallen is of aan andere mechanische belastingen werd blootgesteld.

Vereiste reparaties aan dit laserapparaat mogen alleen worden uitgevoerd door geautoriseerd vakpersoneel.

Gebruik het instrument niet in ruimten met explosiegevaar of in een agressieve omgeving.

 Afgedankte batterijen en afgedankte elektrische en elektronische apparatuur mogen niet samen via het huisafval worden afgevoerd. Afgedankte batterijen en afgedankte elektrische en elektronische apparatuur moeten gescheiden ingezameld en afgevoerd worden.

Verwijder afgedankte batterijen, afgedankte accu's en verlichtingsmiddelen uit de apparatuur voordat u deze afvoert.

Informeer bij uw gemeente of bij uw vakhandelaar naar recyclingbedrijven en inzamelpunten.

Al naargelang de lokaal van toepassing zijnde voorschriften kunnen detailhandelaren verplicht zijn om afgedankte batterijen, afgedankte elektrische en elektronische apparatuur kosteloos terug te nemen.

Geef uw afgedankte batterijen, afgedankte elektrische en elektronische apparatuur af voor recycling en help zo mee om de behoefte aan grondstoffen te verminderen.

Afgedankte batterijen (vooral lithium-ion-batterijen), afgedankte elektrische en elektronische apparatuur bevatten waardevolle, recyclebare materialen die, mits ze niet milieuvriendelijk worden afgevoerd, negatieve gevolgen kunnen hebben voor het milieu en uw gezondheid.

Verwijder persoonlijke gegevens van uw afgedankte apparatuur voordat u deze afvoert.

 Europees symbool van overeenstemming

 Britse conformiteitsmarkering

 Oekraïens symbool van overeenstemming

 Euro-Aziatisch symbool van overeenstemming

## TECHNISCHE GEGEVENS

	LDM 45	LDM 100
Optiek	15 mm x 9 mm	18 mm
Meetbereik		
Minimale afstand	0,05 m	0,05 m
Maximale afstand	45 m (Tolerantie: 45,1 m)	100 m (Tolerantie: 101 m)
Afstandsmeting		
Karakteristieke tolerantie (geldig voor 100 % reflecterend doel (witgelakte muur), geringe achtergrondverlichting, 25 °C)	± 2,0 mm (houd rekening met een extra tolerantie van 0,1 mm/m)	± 2,0 mm (houd rekening met een extra tolerantie van 0,1 mm/m)
Maximale tolerantie (geldig voor doelen met een geringere reflectie, hoge achtergrondverlichting of temperaturen die dichterbij de onderste/hogste waarden liggen)	± 4,0 mm (houd rekening met een extra tolerantie van 0,15 mm/m)	± 4,0 mm (houd rekening met een extra tolerantie van 0,15 mm/m)
Kleinste weergave-eenheid	1,0 mm	1,0 mm
Laserpuntgrootte		
16 m afstand:	25 x 50 mm	25 x 50 mm
Laserklasse	2	2
Lasertype	635 nm, < 1 mW	635 nm, < 1 mW
Laserstraal		
verticale hoek	+1 graad	+1 graad
horizontale hoek	±1 graad	±1 graad
Displaytype	lcd (25 mm x 25 mm)	lcd (25 mm x 25 mm)
Automatische uitschakeling laser	90 seconden	90 seconden
Automatische uitschakeling toestel	180 seconden	180 seconden
Stroomvoorziening	AAA 2x (alkaline-batterij)	AAA 2x (alkaline-batterij)
Batterijlevensduur	8.000 (afzonderlijke metingen)	8.000 (afzonderlijke metingen)
Schroefdraad statief	1/4"	1/4"
Arbeidstemperatuurbereik	-0°C tot +40°C	-0°C tot +40°C
Opslagtemperatuurbereik	-10°C tot +60°C	-10°C tot +60°C
Gewicht zonder batterij	87 g	122 g
Veiligheidsklasse	IP54 (tegen stof en spatwater beschermd)	IP54 (tegen stof en spatwater beschermd)

## VOORGESCHREVEN GEBRUIK VAN HET SYSTEEM

Het lasermeettoestel is geschikt voor het meten van afstanden en neigingen.  
Dit apparaat uitsluitend gebruiken voor normaal gebruik, zoals aangegeven.

## TABEL MET STORINGSCODES

Code	Beschrijving	Maatregel
Err500	Hardwareproblemen	Schakel het meetapparaat uit en weer in. Als het probleem blijft bestaan, kunt u het meetapparaat naar het dichtstbijzijnde servicepunt brengen.

# OVERZICHT

## STATUSBALK

- ▶ Referentiemeetpunt, soort meting, meethoek (alleen met LDM 100), meetniveau (alleen met LDM 100)

## DISPLAY

- ▶ Menu
- ▶ Metingen
- ▶ Instellingen

## NAAR BOVEN / OPTELLEN

- ▶ In het menu naar boven schakelen
- ▶ Waarde optellen

## METING / OK

- ▶ Laser inschakelen
- ▶ Meetwaarde opslaan
- ▶ OK in het menu selecteren

## MENU

- ▶ Geschiedenis
- ▶ Meting
- ▶ Instellingen

## NAAR BENEDEN / AFTREKKEN

- ▶ In het menu naar beneden schakelen
- ▶ Waarde aftrekken

## WISSEN / IN-/UITSCHAKELEN

- ▶ AAN / UIT (toets ingedrukt houden totdat het apparaat een signaalgeluid genereert)
- ▶ Meetwaarde wissen

## MEETPUNT

- ▶ Achter (standaardinstelling)
- ▶ Voor
- ▶ Hoek (wordt automatisch geactiveerd door uitklappen van de pen)



## METEN

- ▶ Laser inschakelen
- ▶ Meetwaarde opslaan

## BATTERIJEN VERVANGEN

- ▶ Batterijen vervangen als het batterijsymbool knippert.

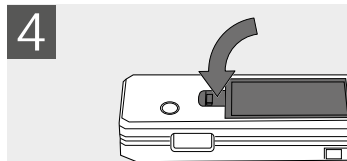
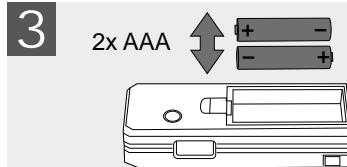
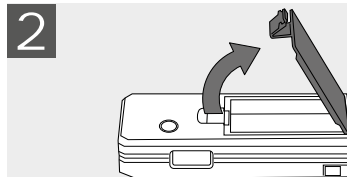
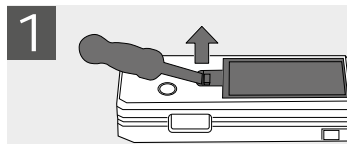

## STATIEF

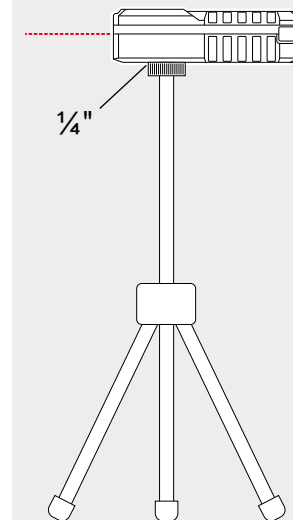

## HOEKPEN

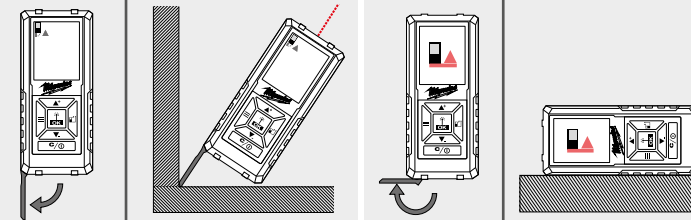

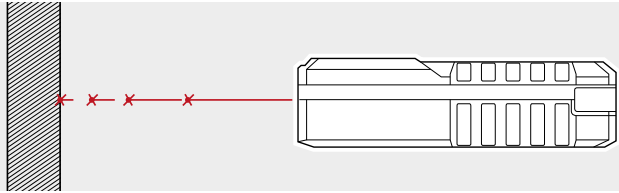

De laserstraal knippert tijdens de meting constant.

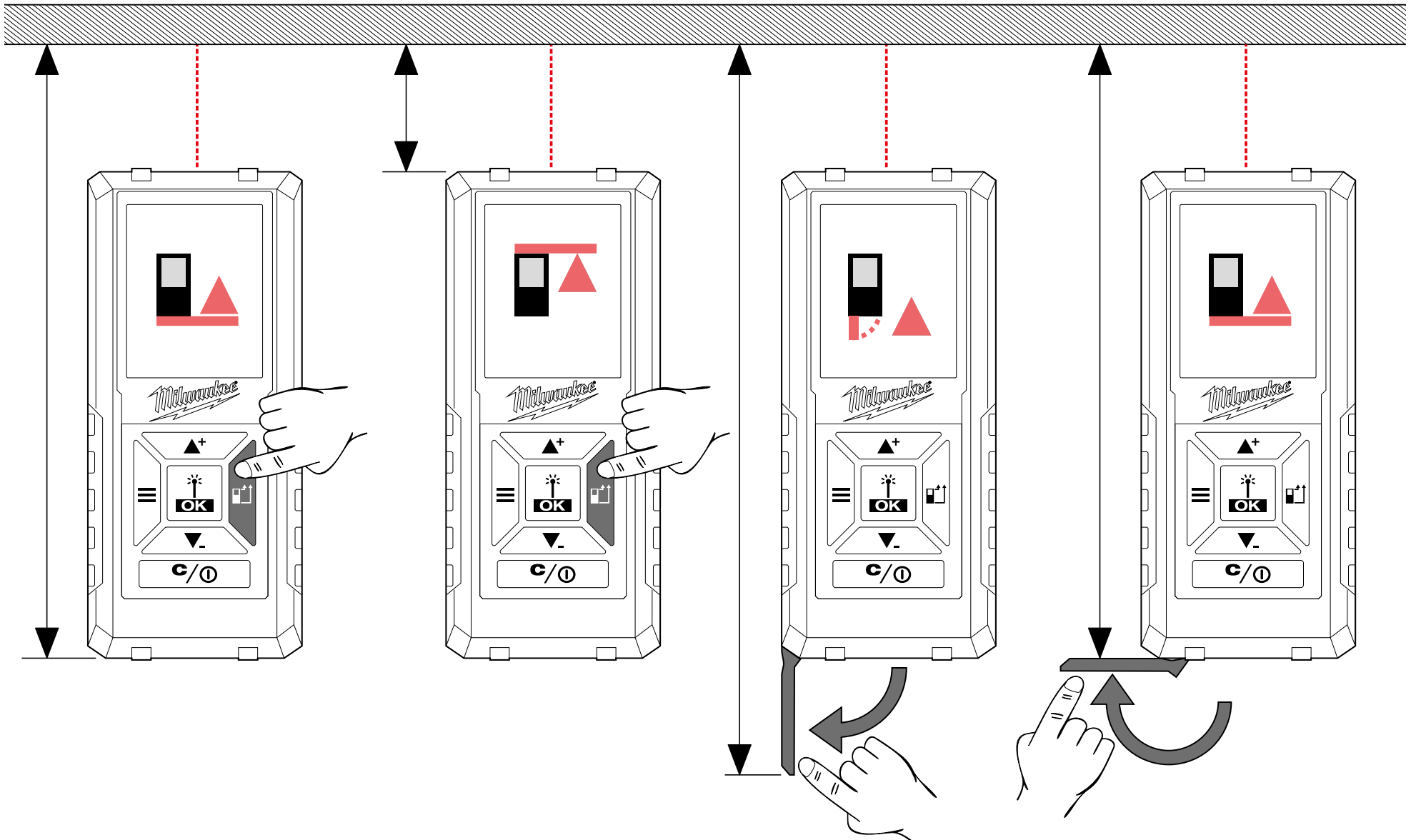

# MENU

## GESCHIEDENIS



Weergave van de afgelopen 30 metingen / berekeningen.

De afzonderlijke metingen voor de berekening van oppervlak, totaal oppervlak, volume enz. worden niet onder GESCHIEDENIS opgeslagen, hier wordt alleen het resultaat van de berekeningen opgeslagen.

Druk op de toets C/AAN/UIT om een invoer te wissen.

Bij de onder GESCHIEDENIS opgeslagen waarden kunnen metingen/berekeningen worden opgeteld of afgetrokken. Het is alleen mogelijk om berekeningen van dezelfde soort uit te voeren (lengte, oppervlak, volume enz.).

Uitvoeren van een berekening:

1. Gebruik de toetsen ▲+ ▼- om een meetmodus uit de GESCHIEDENIS te selecteren.
2. Druk op de OK-toets.
3. Voer de voor de berekening vereiste metingen uit.
4. Druk op de toets OK om de nieuwe berekeningen onder GESCHIEDENIS op te slaan.

## METING

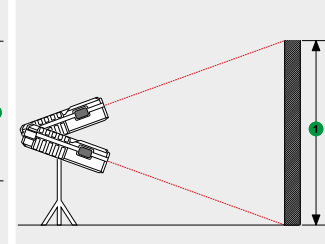
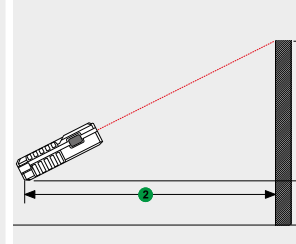
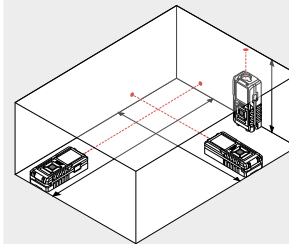
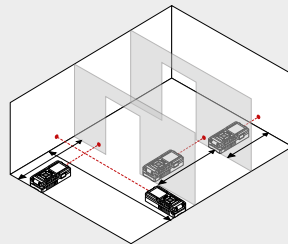
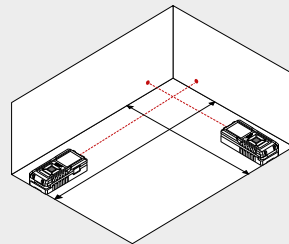
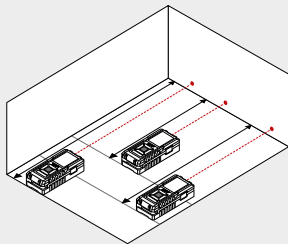
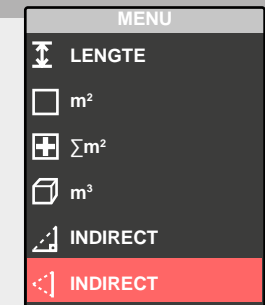

## INSTELLINGEN



Selecteer de gewenste maateenheid.

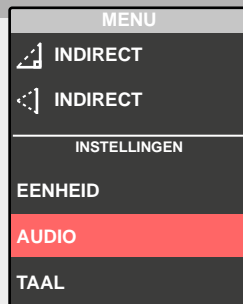



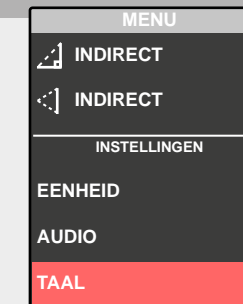

Signaalgeluid aan/uit.

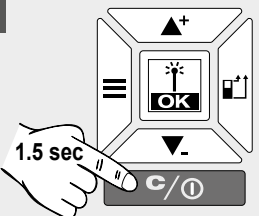
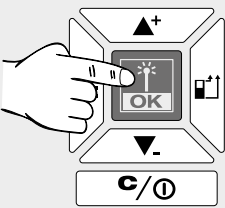
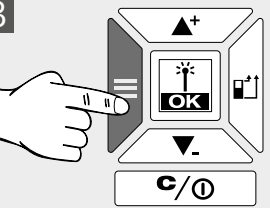
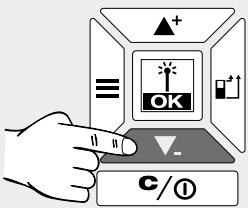
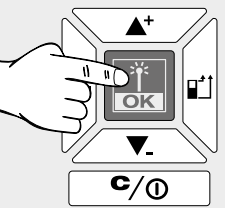

Taal selecteren.

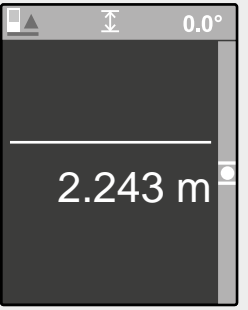
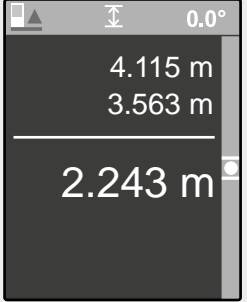
# STARTEN

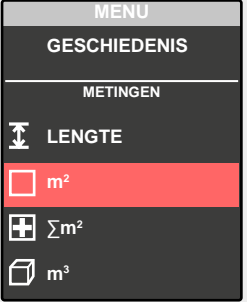
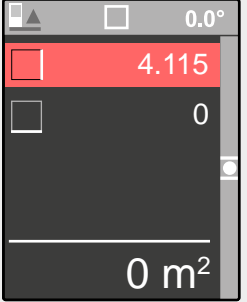
<p>1</p>  <p>1.5 sec</p>	<p>2</p> 	<p>3</p> 	<p>4</p> 	<p>5</p> 
 				
<p>Na het inschakelen wordt automatisch de MODUS VOOR DE LENGTEMETING geactiveerd.</p>	<p>Voer een LENGTEMETING uit of ...</p>	<p>... druk op de menu-toets om naar het menu te schakelen ...</p>	<p>... en selecteer een andere bedrijfsmodus met behulp van de toetsen ▲+ ▼- en ...</p>	<p>... en activeer deze bedrijfsmodus door de toets OK in te drukken.</p>

# LENGTE METEN

0



Meetwaarde wit = waarde gemeten

1

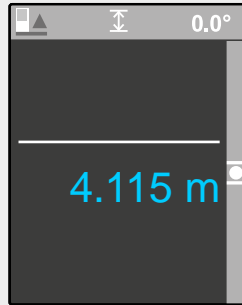
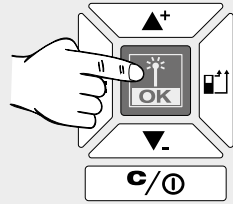

Meetwaarde blauw = waarde tijdelijk opgeslagen

2

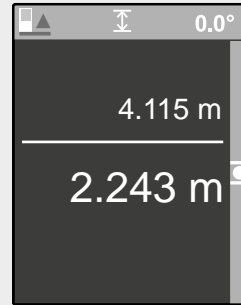
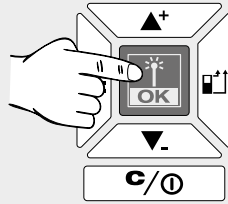

3

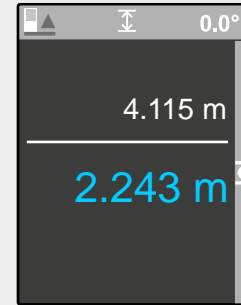
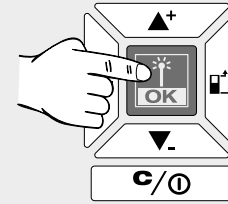

4

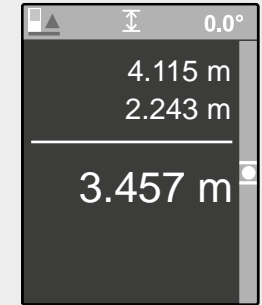
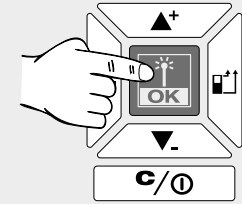

5

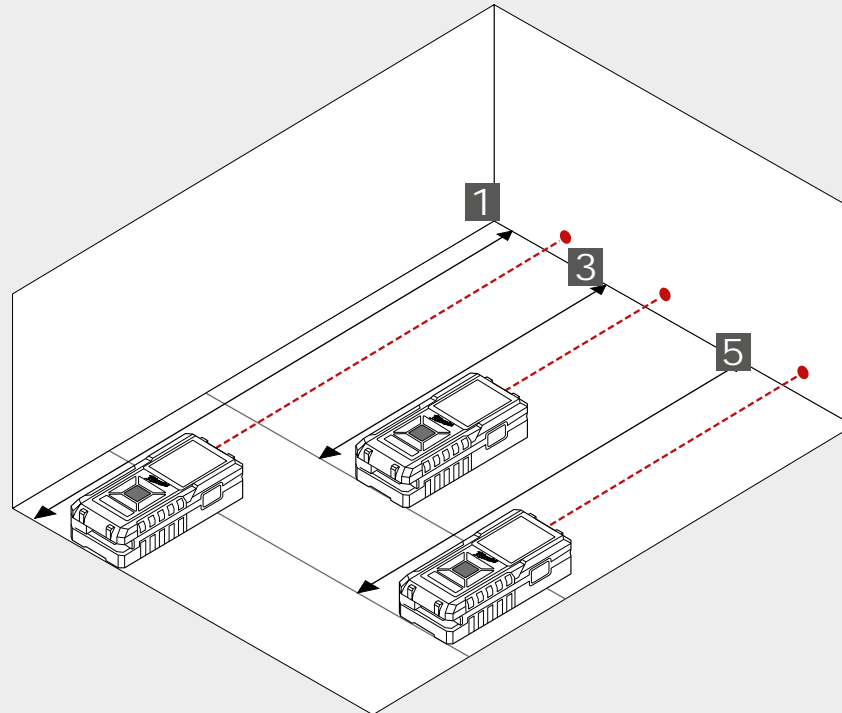
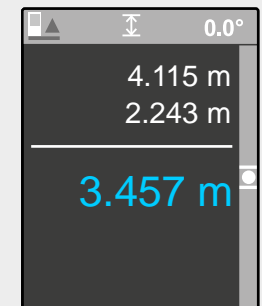
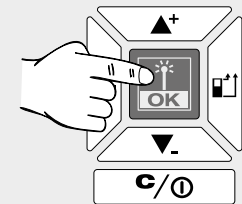



0

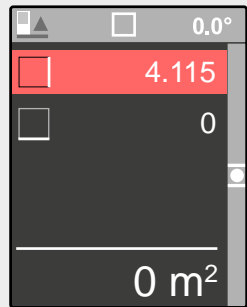

1

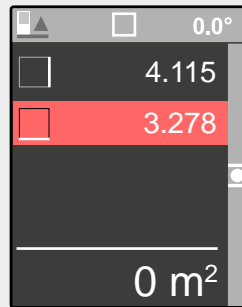
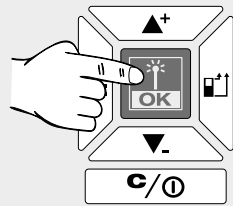

2

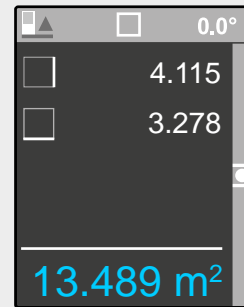
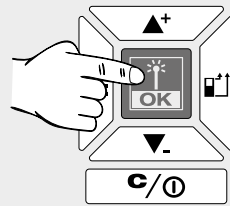

2

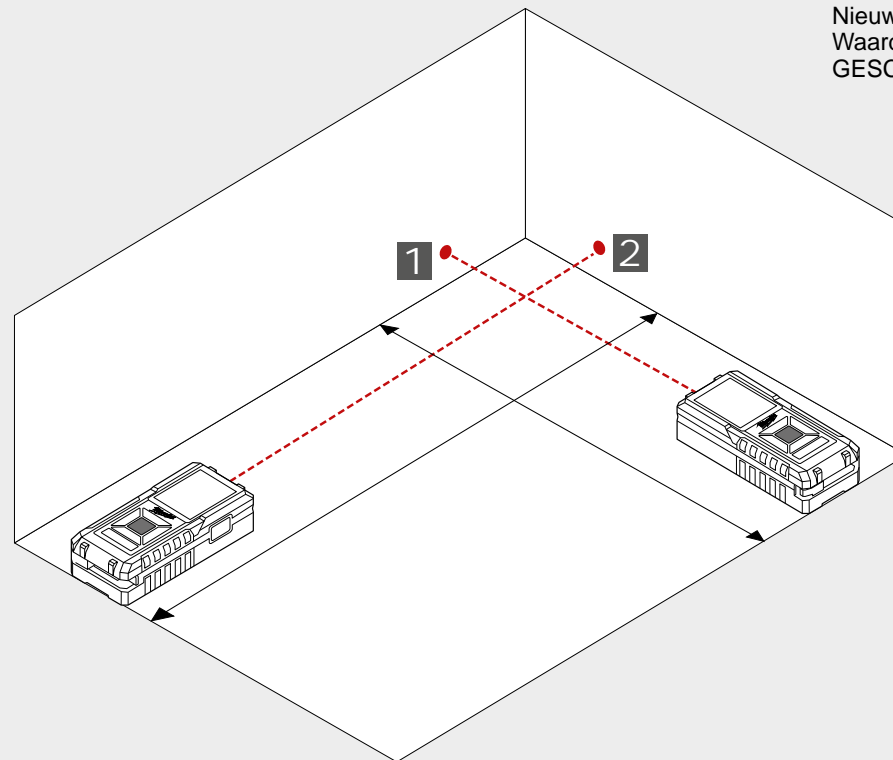
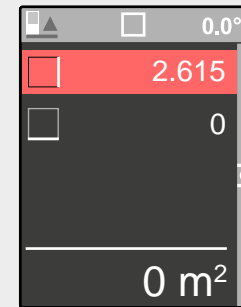
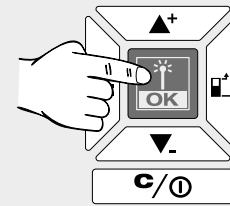

Nieuwe meting.  
Waarde wordt opgeslagen onder  
GESCHIEDENIS.

# TOTAAL OPPERVLAK METEN

0

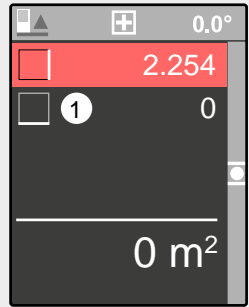

1

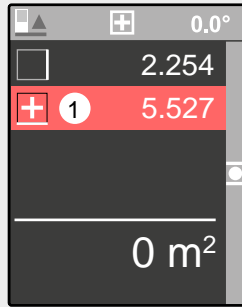
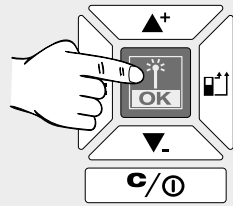

2

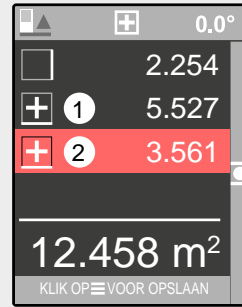
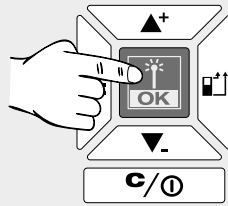

3

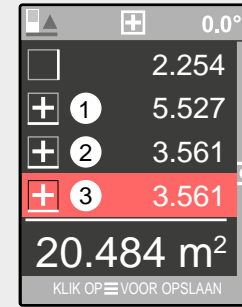
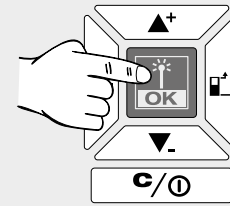

4

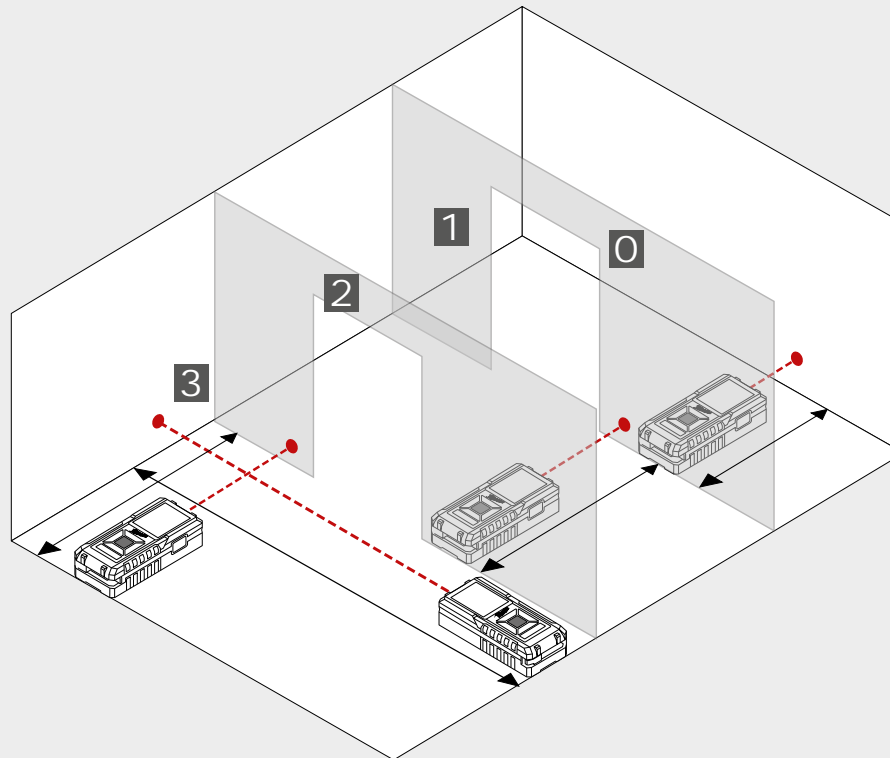
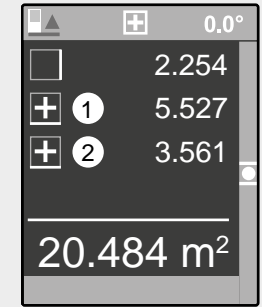
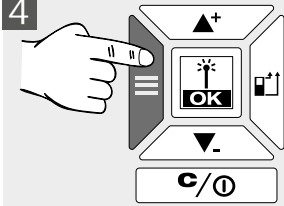

4

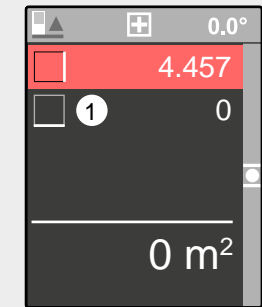
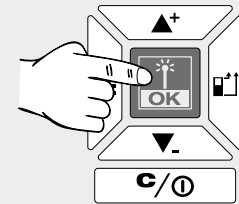

Nieuwe meting.  
Resultaat wordt opgeslagen onder  
GESCHIEDENIS.

# VOLUME METEN

0

1

2

3

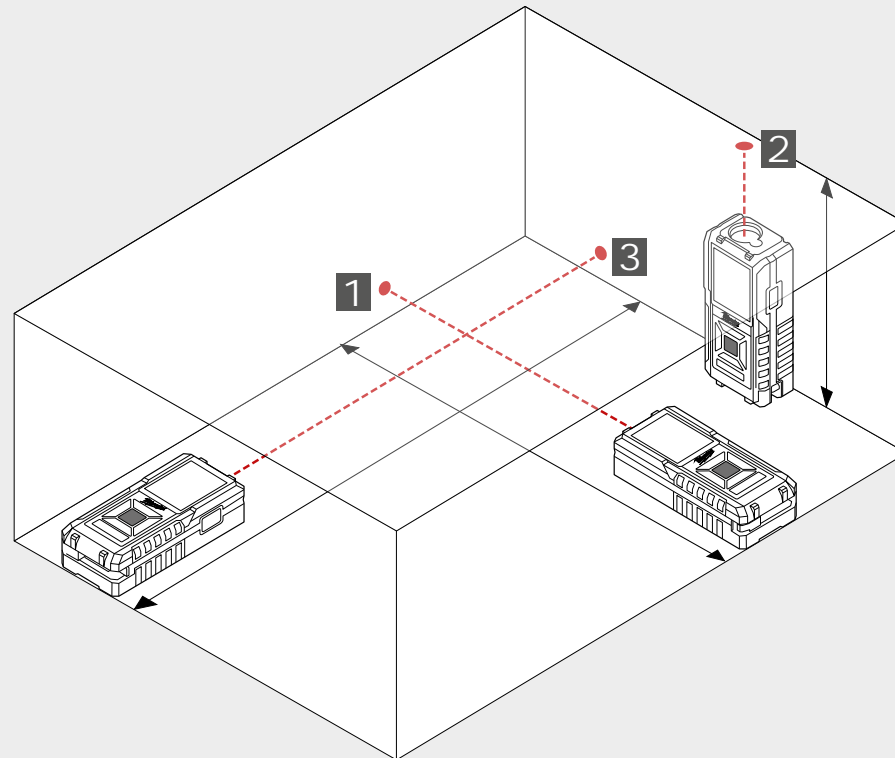
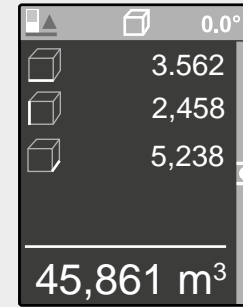
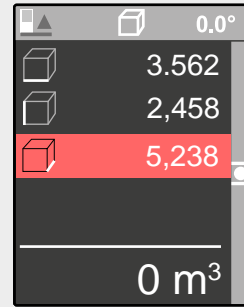
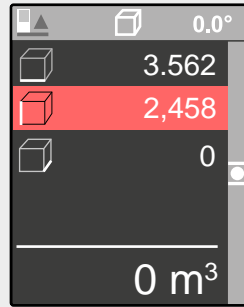
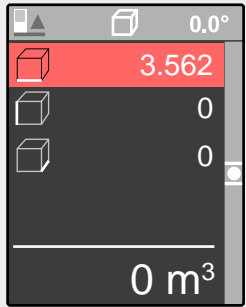
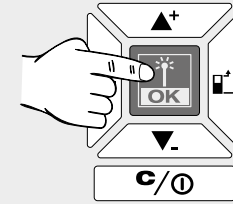
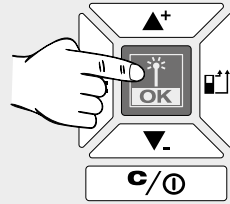
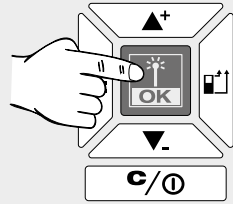

# INDIRECTE HOOGTE-/LENGTEMETING (ALLEEN MET LDM 100)

0

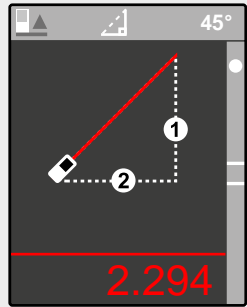

1

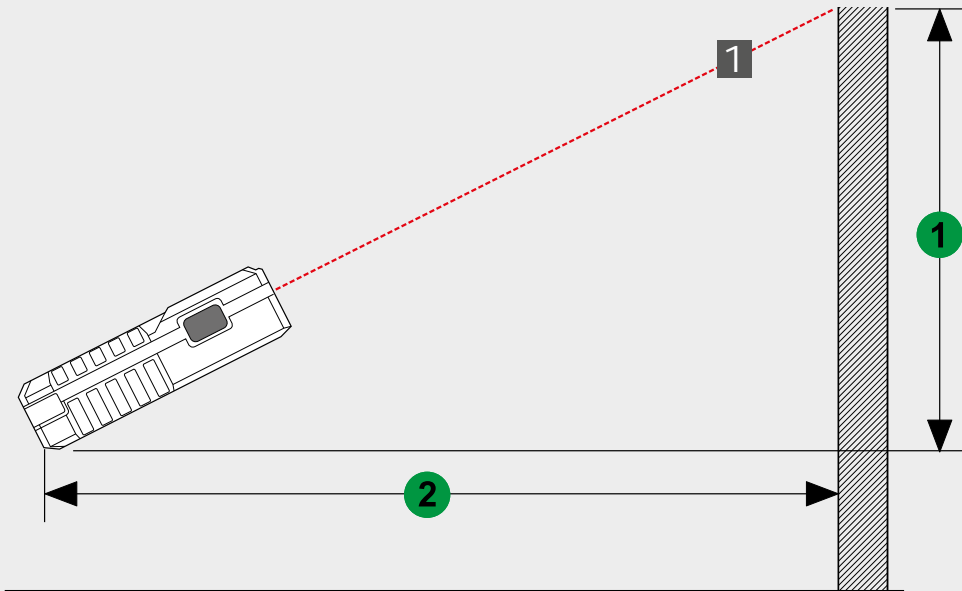
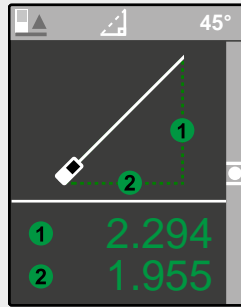
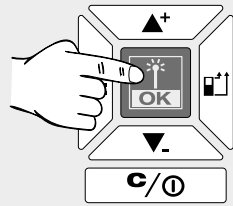

# INDIRECTE HOOGTEMETING (ALLEEN MET LDM 100)

0

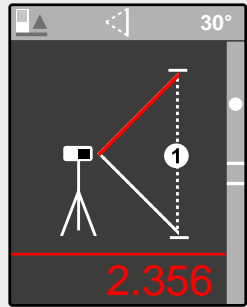

1

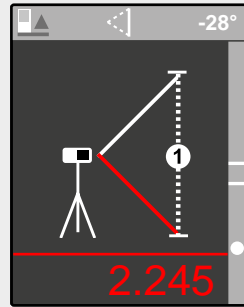
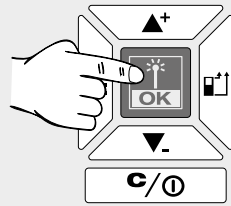

2

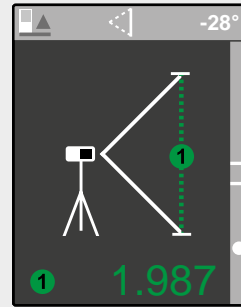
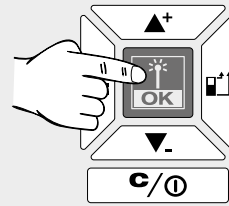

Gebruik een statief of een ander stabiel oppervlak om twee verschillende lengten te meten.

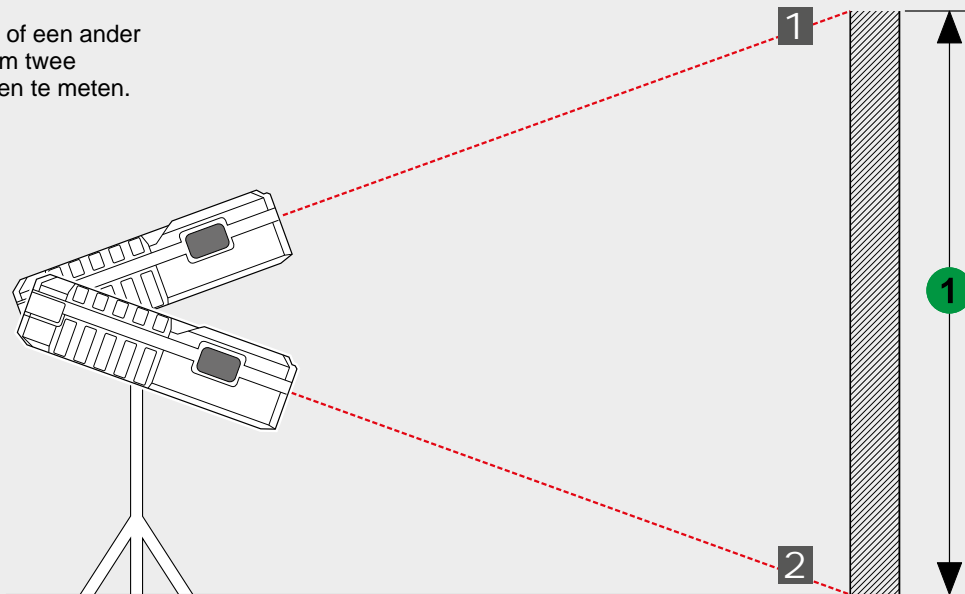

## INDHOLD

Vigtige sikkerheds- instruktioner.....	1
Tekniske data.....	2
Tiltænkt Formål.....	2
Fejlkode Tabel .....	2
Oversigt.....	3
Målepunkt.....	4
Menu.....	5
Start.....	6
Måling af længde.....	7
Måling af areal.....	8
Måling af samlet areal .....	9
Måling af volumen .....	10
Indirekte højde-/længdemåling (kun med LDM 100) .....	11
Indirekte højdemåling (kun med LDM 100) .....	12

## VIGTIGE SIKKERHEDS- INSTRUKTIONER



Brug ikke produktet før du har læst sikkerhedsinstruktionerne og brugervejledningen på vedlagte CD.

### Laserklassificering

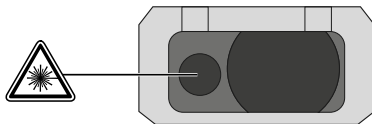

### ADVARSEL:

Det er et Klasse 2 laserprodukt i overensstemmelse med EN60825-1:2014



LASERPRODUKT TIL FORBRUGERE  
EN 50689:2021

### Advarsel:

Undgå en direkte synskontakt. Laserstrålen kan forårsage blizt blindhed og føre til en kortvarig blænding.

Se aldrig ind i laserstrålen og ret den ikke unødigt mod andre personer.

Blænd ikke andre personer.

### Advarsel:

Betjen ikke laserapparatet i nærheden af børn eller tillad ikke børn at benytte laserapparatet.

OBS!! En reflekterende overflade kunne reflektere laserstrålen tilbage til brugeren eller andre personer.

Hold arme og ben i sikker afstand fra bevægelige dele.

Udfør regelmæssige testmålinger. Især før, under og efter vigtige målinger.

Vær opmærksom på fejl-målinger, hvis produktet er defekt, eller hvis det er blevet tabt eller er blevet misbrugt eller modificeret.

**Advarsel:** Anvendelse af andre styreelementer, indstillinger eller procedurer end angivet her i manualen kan føre til farlig strålebelastning.

Laserafstandsmåleren har grænser for sit anvendelsesområde. (Se afsnittet Tekniske data). Det vil forårsage unøjagtigheder at forsøge at måle uden for det maksimale og minimale område. Bruges instrumentet ved ugunstige betingelser som hvis det er for varmt eller for koldt, meget kraftigt sollys, regn, sne, tåge

eller andre sigtbegrænsende betingelser kan det føre til unøjagtige målinger.

Hvis laserafstandsmåleren kommer fra varme omgivelser til kolde (eller omvendt), så vent, indtil den har tilpasset sig til den nye omgivelsestemperatur.

Opbevar altid laserafstandsmåleren indendørs, beskyt den mod stød, vibrationer eller ekstreme temperaturer.

Beskyt laserafstandsmåleren mod støv, fugtighed og høj luftfugtighed. Dette kan ødelægge indvendige komponenter eller påvirke nøjagtigheden.

Brug ikke aggressive rengøringsmidler eller opløsningsmidler. Rengør kun instrumentet med en ren, blød klud.

Undgå at laserafstandsmåleren udsættes for kraftige stød eller at tabe den. Instrumentets nøjagtighed skal kontrolleres, hvis det er faldet ned eller har været udsat for andre mekaniske belastninger.

Nødvendige reparationer på dette laserapparat skal udføres af autoriserede fagfolk.

Brug ikke produktet i områder med eksplosions-fare eller under barske forhold.

 Udtjente batterier, affald af elektrisk og elektronisk udstyr må ikke bortskaffes sammen med husaffald. Udtjente batterier, affald af elektrisk og elektronisk udstyr skal indsamles og bortskaffes særskilt.

Fjern udtjente batterier, udtjente akkumulatorer og lysmidler fra udstyret, inden det bortskaffes.

Spørg efter genbrugsstationer og indsamlingssteder hos de lokale myndigheder eller din fagforhandler.

Alt efter de lokale bestemmelser kan detailhandlende være forpligtede til gratis at tage brugte batterier, affald af elektrisk og elektronisk udstyr tilbage.

Bidrag til at nedbringe behovet for råmaterialer ved at genbruge og genanvende dine udtjente batterier, affald af elektrisk og elektronisk udstyr.

Udtjente batterier (især lithium-ion-batterier), affald af elektrisk og elektronisk udstyr indeholder værdifulde, genanvendelige materialer, som kan have en negativ effekt på miljøet og dit helbred ved ikke miljørigtig bortskaffelse.

Slet inden bortskaffelsen personrelaterede data, som måtte befinde sig på dit affald af udstyret.

 Europæisk overensstemmelsesmærke

 Britisk overensstemmelsesmærkning

 Ukrainisk konformitetsmærke

 Eurasisk konformitetsmærke

## TEKNISKE DATA

	LDM 45	LDM 100
Modtagelinse	15 mm x 9 mm	18 mm
Måleområde		
Minimal afstand	0,05 m	0,05 m
Maksimal afstand	45 m (Tolerance: 45,1 m)	100 m (Tolerance: 101 m)
Afstandsmåling		
Typisk tolerance (gælder for 100 % målrefleksion (hvidmalet væg), svag baggrundsbelysning, 25 °C)	± 2,0 mm (der bør tages højde for en yderligere tolerance på 0,1 mm/m)	± 2,0 mm (der bør tages højde for en yderligere tolerance på 0,1 mm/m)
Maksimal tolerance (gælder for måloverflader med svag refleksion, kraftig baggrundsbelysning eller temperaturer, som nærmer sig højeste/ laveste værdi)	± 4,0 mm (der bør tages højde for en yderligere tolerance på 0,15 mm/m)	± 4,0 mm (der bør tages højde for en yderligere tolerance på 0,15 mm/m)
Mindste visbare enhed	1,0 mm	1,0 mm
Laserpunktstørrelse		
16 meters afstand:	25 x 50 mm	25 x 50 mm
Laserklasse	2	2
Lasertype	635 nm, < 1 mW	635 nm, < 1 mW
Laserstråle		
vertikalvinkel	+1 grad	+1 grad
horisontalvinkel	±1 grad	±1 grad
Display type	LCD (25 mm x 25 mm)	LCD (25 mm x 25 mm)
Automatisk slukning af laser	90 sekunder	90 sekunder
Automatisk slukning af instrumentet	180 sekunder	180 sekunder
Strømforsyning	AAA 2x (alkaline batteri)	AAA 2x (alkaline batteri)
Batteriets levetid	8000 (enkelt måling)	8000 (enkelt måling)
Stativets gevind	1/4"	1/4"
Arbejdstemperatur område	-0°C op til +40°C	-0°C op til +40°C
Opbevaringstemperatur område	-10°C op til +60°C	-10°C op til +60°C
Vægt uden batteri	87 g	122 g
Kapslingsklasse	IP54 (støv- og stænkvangdsbeskyttet)	IP54 (støv- og stænkvangdsbeskyttet)

## TILTÆNKT FORMÅL

Laserafstandsmåleren er egnet til måling af afstande og hældninger.

Produktet må ikke anvendes på anden måde og til andre formål end foreskrevet.

## FEJLKODE TABEL

Kode	Beskrivelse	Løsning
Err500	Hardwareproblemer	Sluk for afstandsmåleren og tænd for den igen. Hvis problemet stadig er der, så indlever afstandsmåleren til nærmeste serviceforhandler.

# OVERSIGT

## STATUSLISTE

- ▶ Referencemålepunkt, målingstype, målevinkel (kun med LDM 100), måleniveau (kun med LDM 100)

## DISPLAY

- ▶ Menu
- ▶ Målinger
- ▶ Indstillinger

## OP / ADDÉR

- ▶ Gå op i menuen
- ▶ Addér værdi

## MÅLING / OK

- ▶ Tænd for laser
- ▶ Gem måleværdi
- ▶ Vælg OK i menuen

## MENU

- ▶ Historik
- ▶ Måling
- ▶ Indstillinger

## NED / SUBTRAHER

- ▶ Gå ned i menuen
- ▶ Subtrahér værdi

## SLET / TÆND/SLUK

- ▶ TÆND/SLUK (hold tasten nede, indtil der lyder en signaltone fra enheden)
- ▶ Slet måleværdi

## MÅLEPUNKT

- ▶ Bagved (standardindstilling)
- ▶ Foran
- ▶ Hjørne (aktiveres automatisk via udklappning af armen)

## MÅLING

- ▶ Tænd for laser
- ▶ Gem måleværdi

## SKIFT BATTERIER

- ▶ Skift batterier, når batterisymbolet blinker.

1

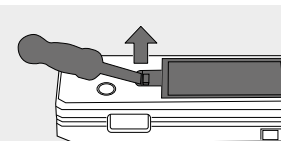

2

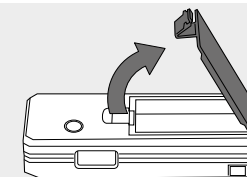

3

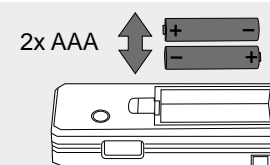

4

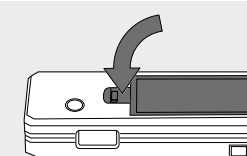

## STATIV

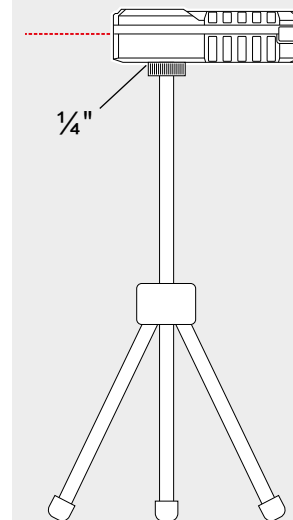

## HJØRNESTIFT

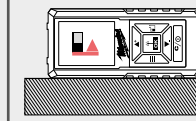
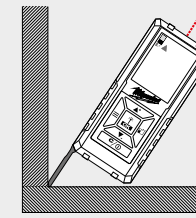



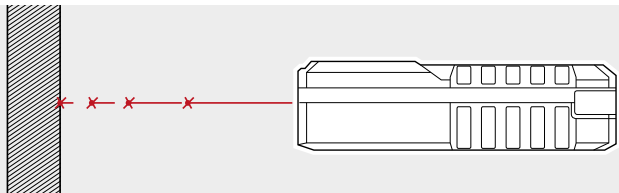

Laserstrålen blinker kontinuerligt under målingen.

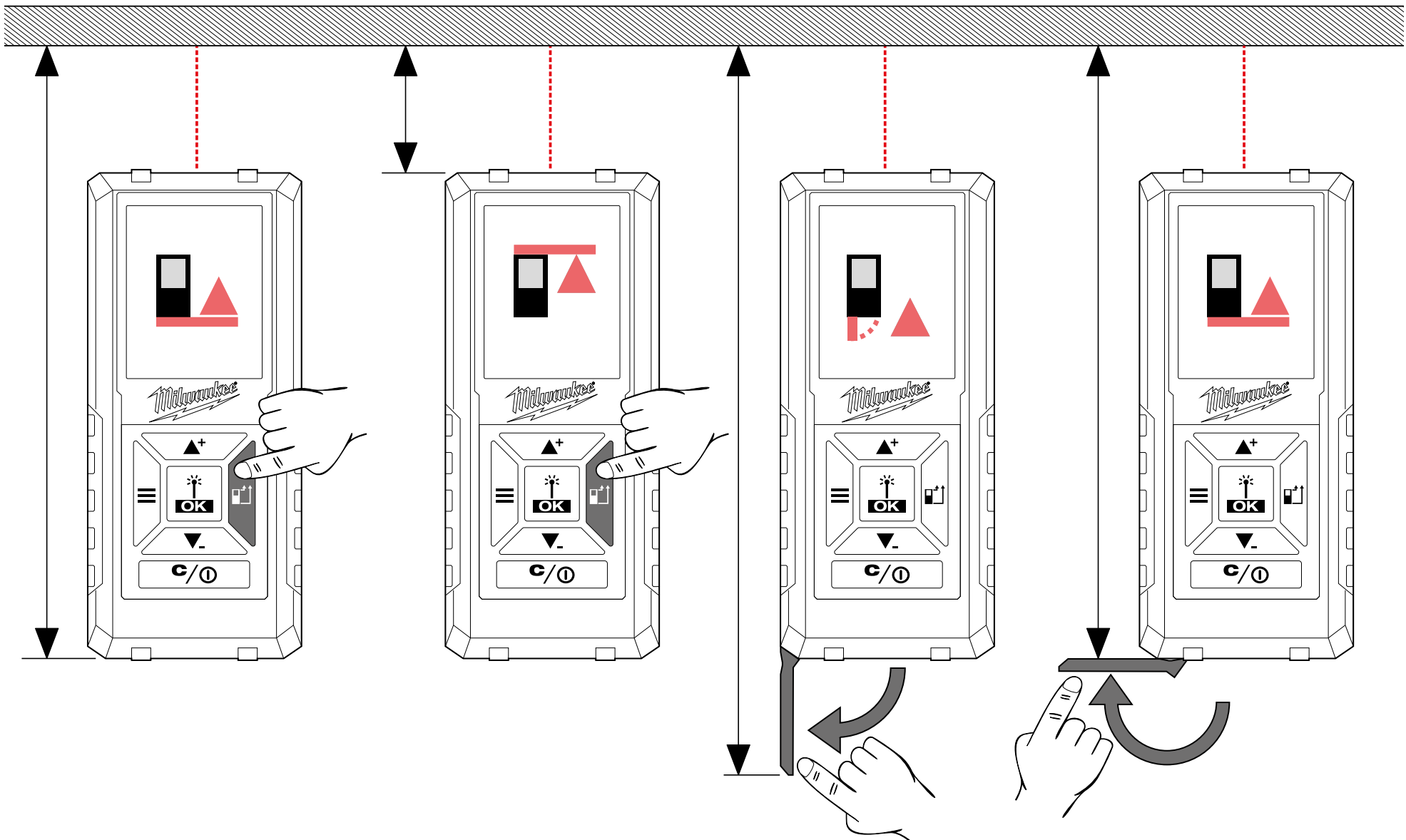

## MENU

### HISTORIK



Visning af de sidste 30 målinger/beregninger  
De enkelte målinger til beregning af overflade, samlet areal, volumen osv. gemmes ikke under HISTORIK, men kun resultatet af beregningerne.

Tryk på tast C/ TÆND/SLUK for at slette en registrering.

Der kan adderes eller subtraheres målinger/beregninger til/fra værdierne gemt under HISTORIK. Der kan kun udføres beregninger af samme type (længde, areal, volumen osv.).

Gennemførelse af en beregning:

1. Brug tasterne  $\blacktriangle$   $\blacktriangledown$ - til at vælge en individuel måling fra HISTORIK.
2. Tryk på OK-tasten.
3. Gennemfør de(n) måling(er), som er nødvendig(e) til beregningen.
4. Tryk på tast OK for at gemme den nye beregning i HISTORIK.

### MÅLING

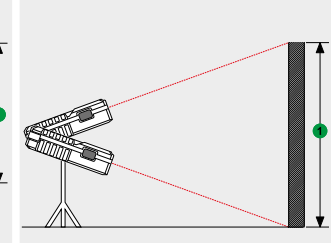
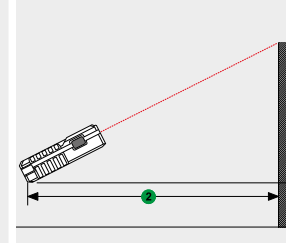
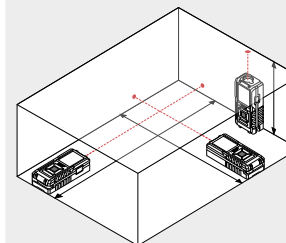
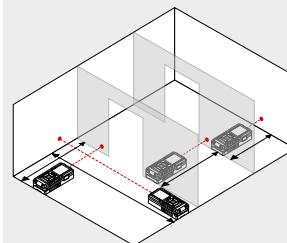
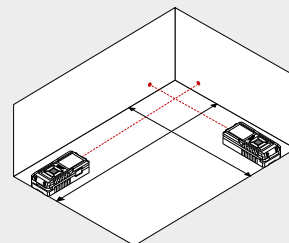
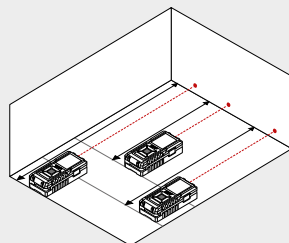
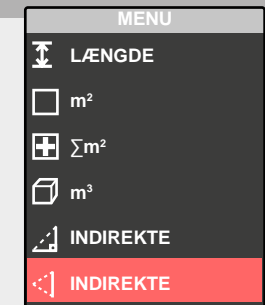
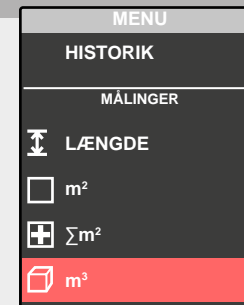
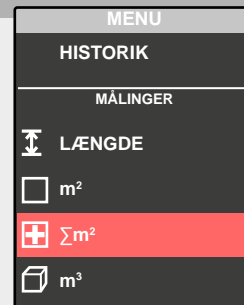
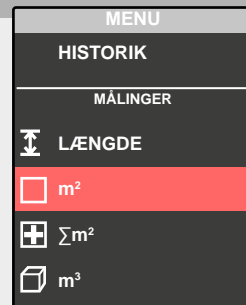
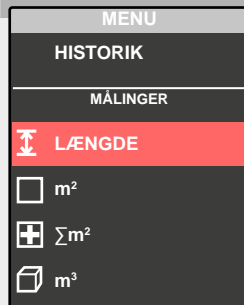

### INDSTILLINGER

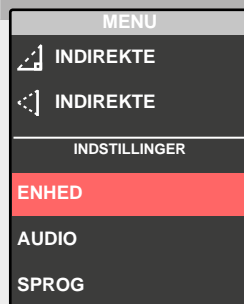

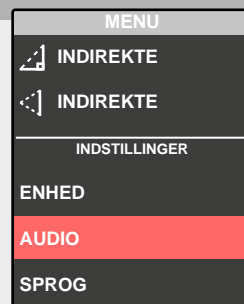

Vælg den ønskede måleenhed.

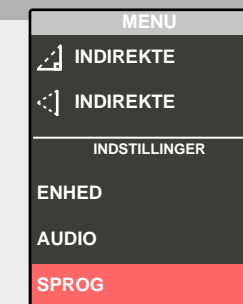

Signaltone til/fra.

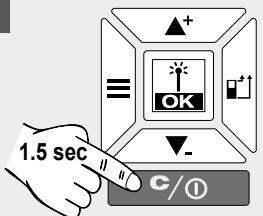
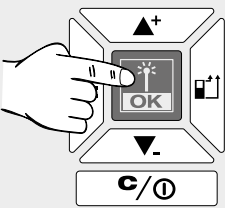
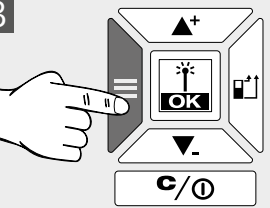
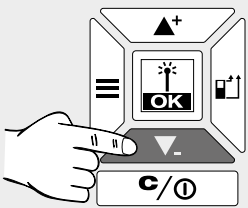
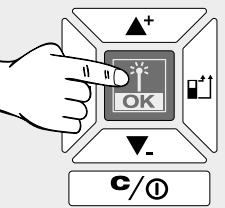

Vælg sprog.

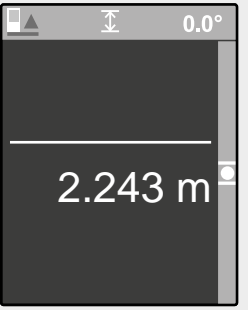
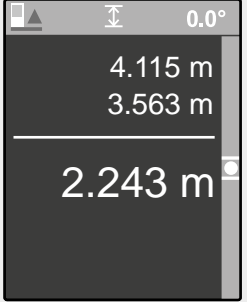
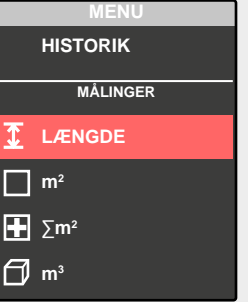
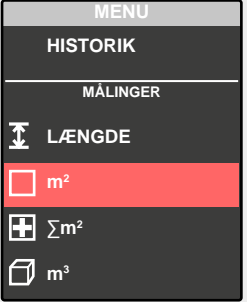
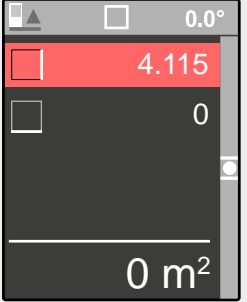
<p>1</p> 	<p>2</p> 	<p>3</p> 	<p>4</p> 	<p>5</p> 
 				
<p>Efter tilkoblingen aktiveres LÆNGDEMÅLINGSSSENSOREN automatisk.</p>	<p>Udfør en LÆNGDEMÅLING eller ...</p>	<p>... tryk på menutasten for at skifte til menuen ...</p>	<p>... og vælg en ny driftsmåde ved hjælp af tasterne ▲<sup>+</sup> ▼<sup>-</sup> og ...</p>	<p>... og aktivér driftsmåden ved at trykke på tasten OK.</p>

# MÅLING AF LÆNGDE

0

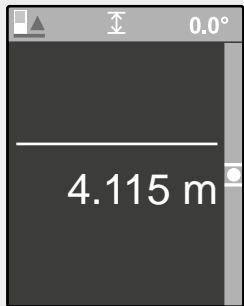

Måleværdi hvid = værdi målt

1

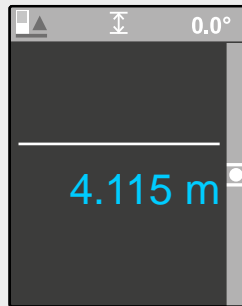
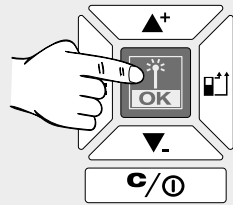

Måleværdi blå = værdi gemt midlertidigt

2

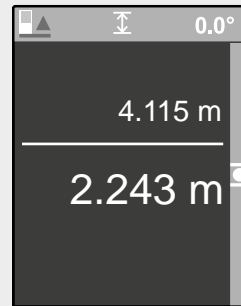
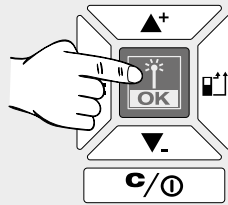

3

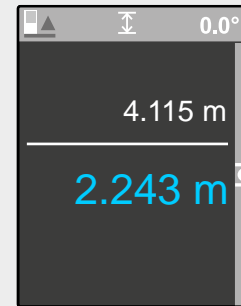
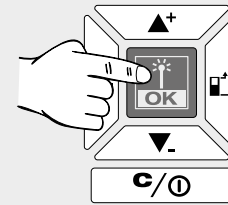

4

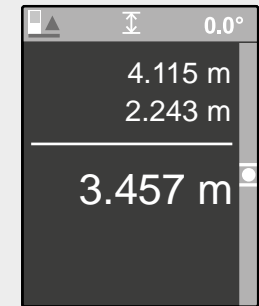
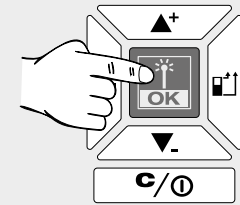

5

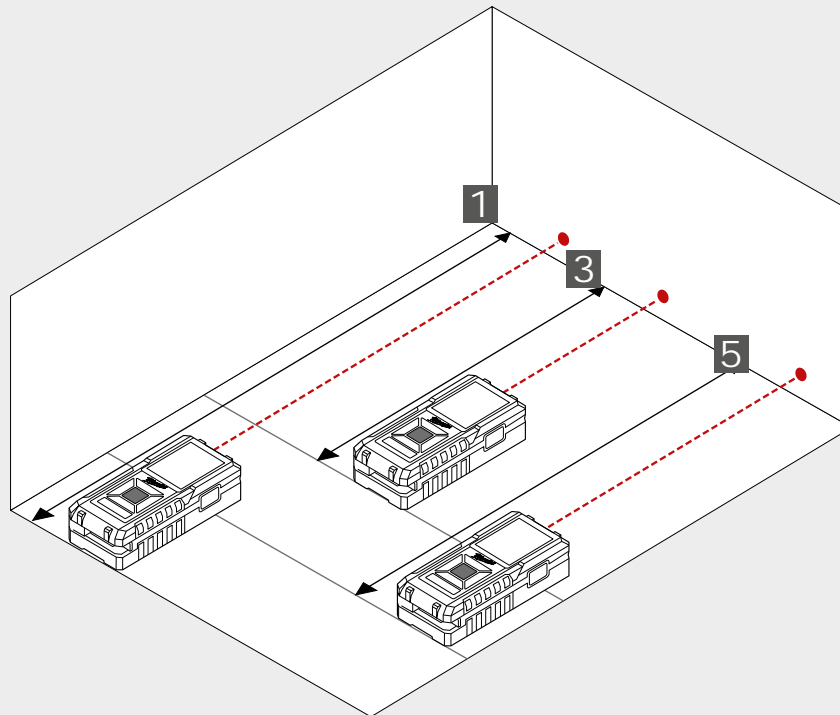
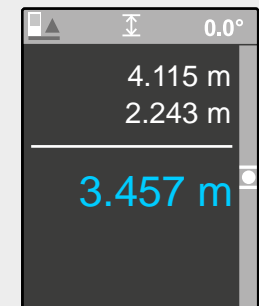
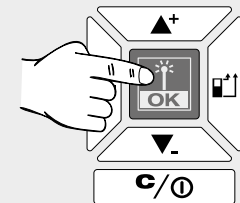

# MÅLING AF AREAL

0

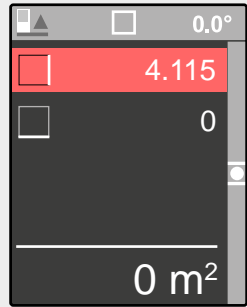

1

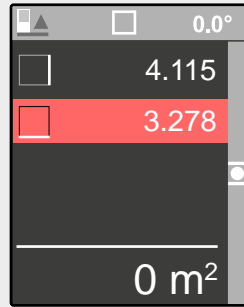
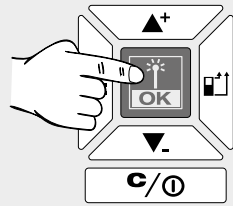

2

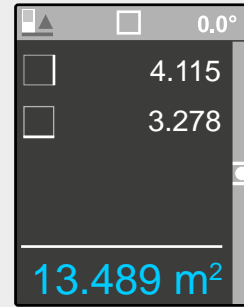
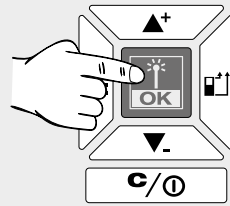

2

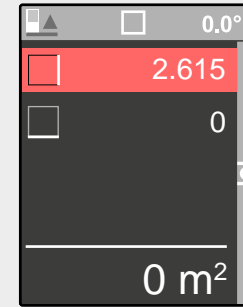
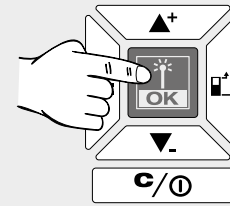

Ny måling.  
Værdien gemmes under PROCES.

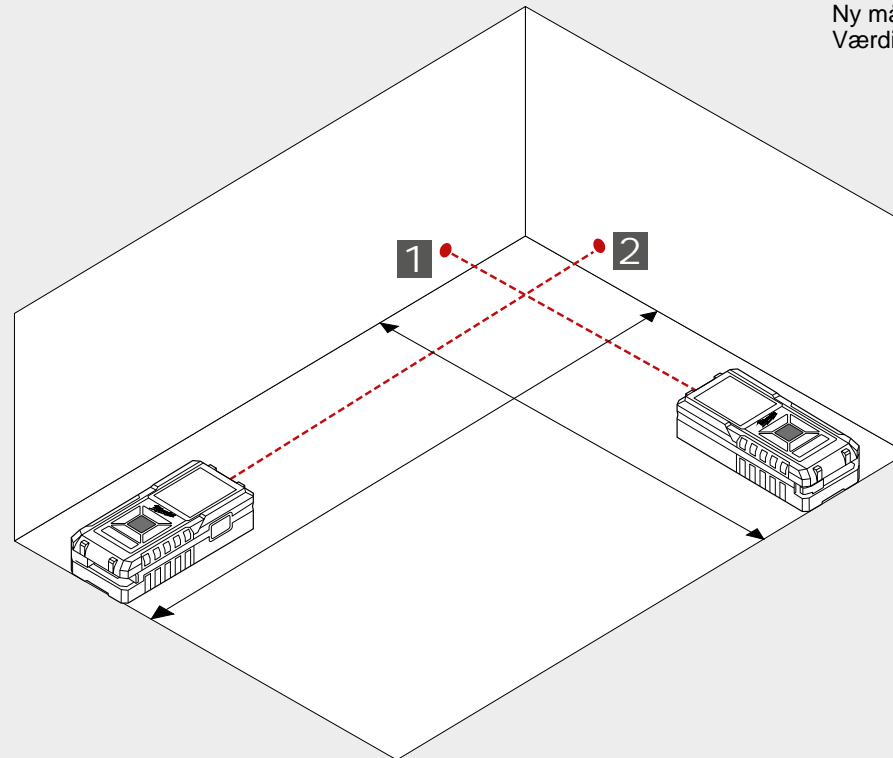

# MÅLING AF SAMLET AREAL

0

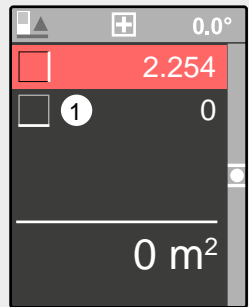

1

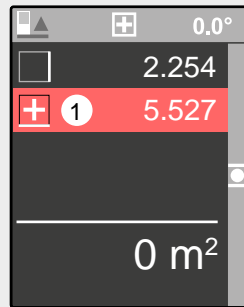
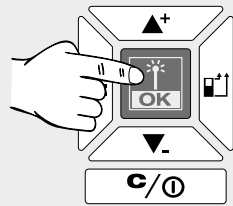

2

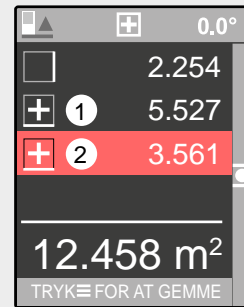
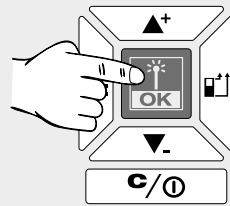

3

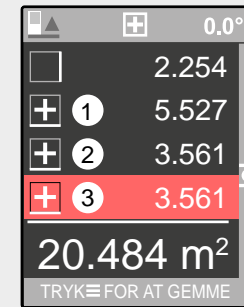
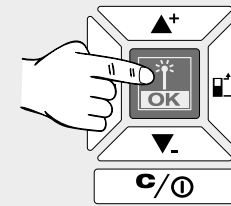

4

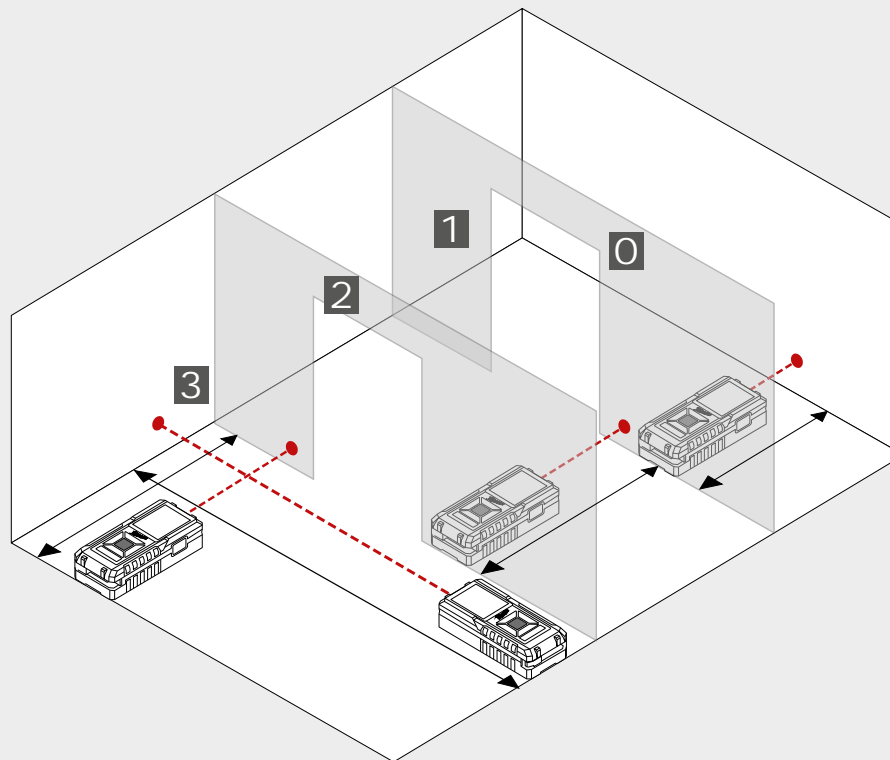
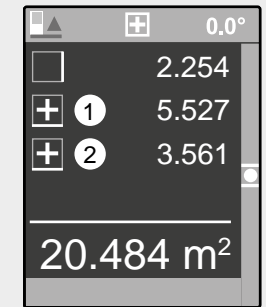
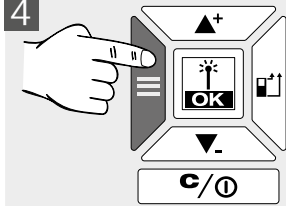

4

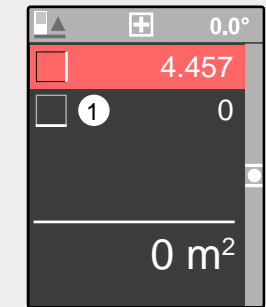
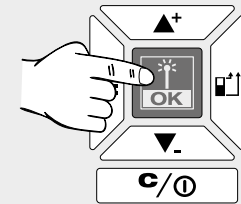

Ny måling.  
Resultatet gemmes under PROCES.

# MÅLING AF VOLUMEN

0

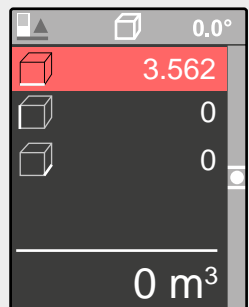

1

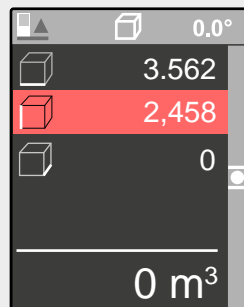
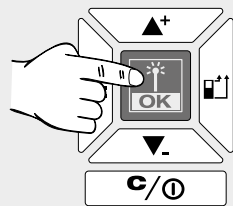

2

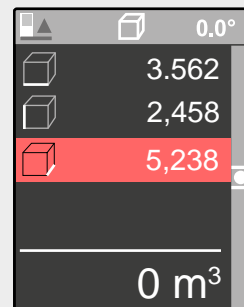
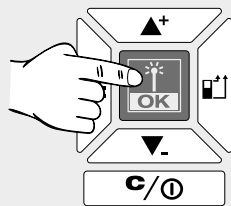

3

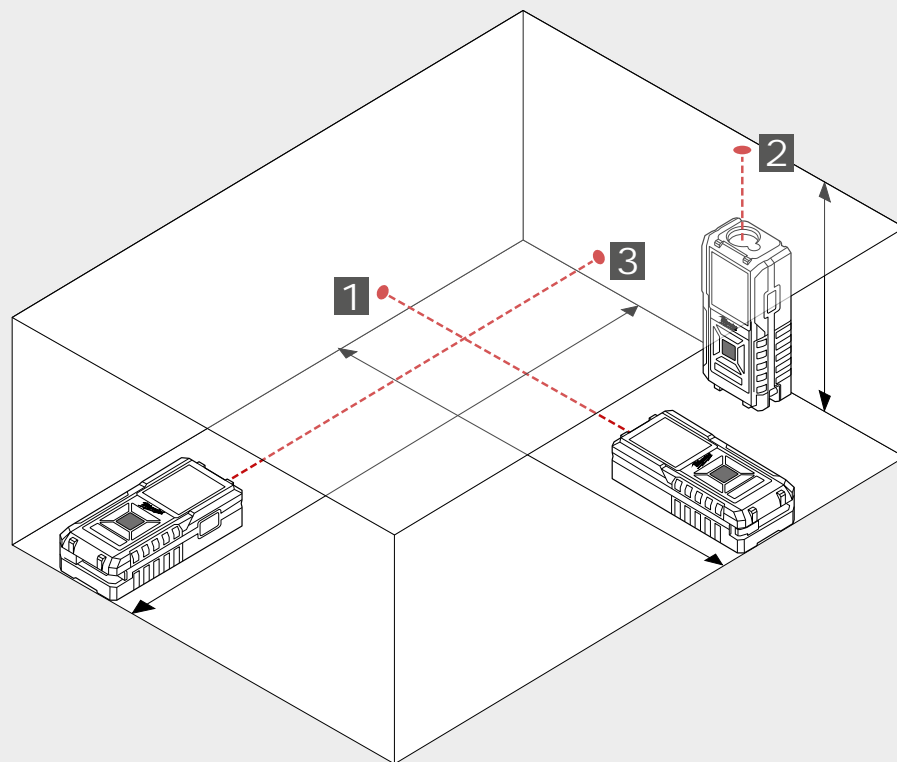
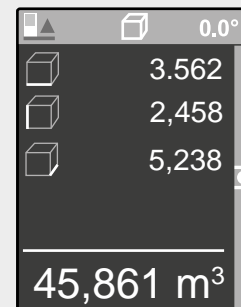
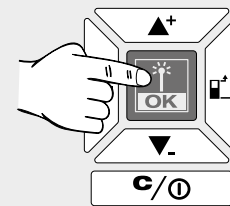

# INDIREKTE HØJDE-/LÆNGDEMÅLING (KUN MED LDM 100)

0

1

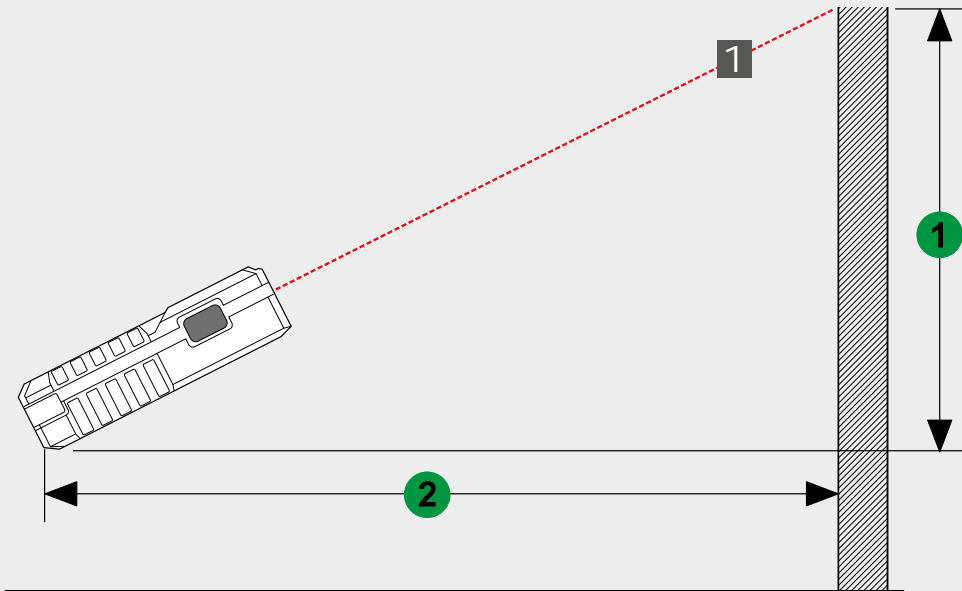
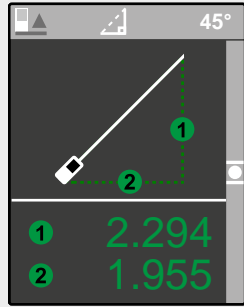
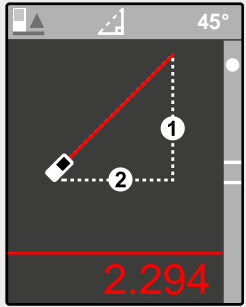
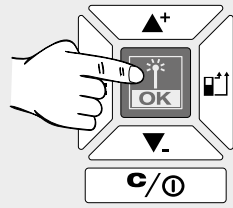



# INDIREKTE HØJDEMÅLING (KUN MED LDM 100)

0

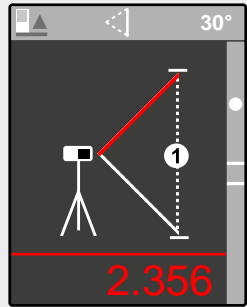

1

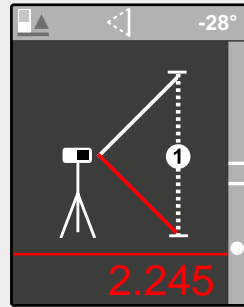
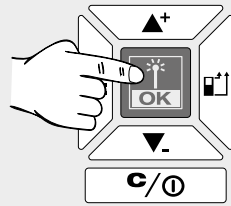

2

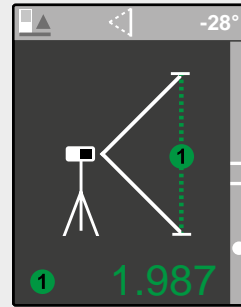
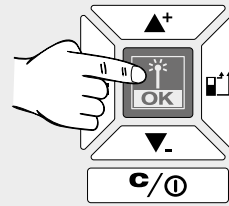

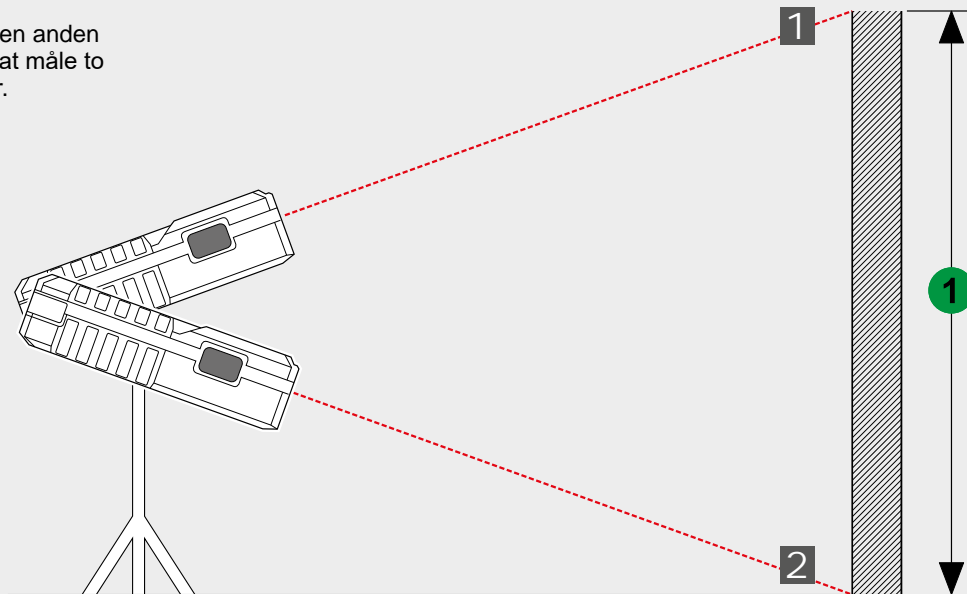

Brug et stativ eller en anden stabil overflade til at måle to forskellige længder.



## INNHold

Viktige sikkerhetsinstruksjoner .....	1
Tekniske data .....	2
Formålmessig bruk .....	2
Feilkode tabell .....	2
Oversikt .....	3
Målingspunkt .....	4
Meny .....	5
Start .....	6
Måling av lengde .....	7
Måling av flate .....	8
Måling av hele arealet .....	9
Måling av volum .....	10
Indirekte høyde-/Lengdemåling (bare med LDM 100) .....	11
Indirekte høydemåling (bare med LDM 100) .....	12

## VIKTIGE SIKKERHETSINSTRUKSER

  Ikke bruk produktet før du har studert sikkerhetsinstruksene og brukerhåndboken på vedlagte CD.

### Laserklassifisering

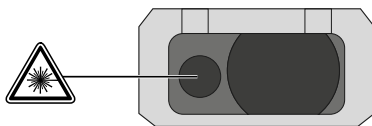

### ADVARSEL:

Dette er et Class 2 laserprodukt i henhold til EN60825-1:2014



LASERAPPARAT FOR SLUTTFORBRUKERE  
EN 50689:2021

### OBS:

Unngå direkte øye kontakt. Laserstrålen kan gi blitzer i øynene, noe som kan føre til en midlertidig blinding.

Unngå å inn i laserstrålen og å rette den unødig mot andre personer.

Ikke pek mot andre personer.

### Advarsel:

Ikke bruk laser apparatet i nærheten av barn. Ikke tillat at barn benytter laser-apparatet.

OBS! En reflekterende overflate kan sende laserstrålen tilbake til bruker eller reflektere andre personen.

Hold kroppsdeler i sikker avstand til deler som beveger seg.

Gjennomfør regelmessig kontrollmålinger. Spesielt før, under og etter viktige målinger.

Se opp for feilmålinger hvis det er feil ved instrumentet, hvis det har falt i bakken, hvis det har vært utsatt for ikke tillatte belastninger, eller hvis det har blitt ombygd.

**Advarsel:** Bruk av styreelement, innstillinger eller gjennomføring av andre fremgangsmåter enn de som er fastlagt i håndboken kan føre til farlig strålebelastning.

Lasermåleapparatet har et begrenset bruksområde. (Se avsnitt Tekniske data). Forsøk på måling utenfor det minimale og maksimale område forårsaker unøyaktigheter. Bruk ved vanskelige betingelser som for varmt, for kaldt, svært sterkt sollys, regn, snø, tåke eller andre betingelser som innskrenker sikten, kan føre til unøyaktige målinger.

Dersom lasermåleapparatet blir brakt fra en varm omgivelse til en kald omgivelse (eller omvendt), må det ventes til apparatet har tilpasset seg den nye omgivelsestemperaturen.

Lasermåleapparatet skal alltid oppbevares i rom som beskytter apparatet mot rystelse, vibrasjoner og ekstreme temperaturer.

Lasermåleapparatet skal beskyttes mot støv, væte og høy luftfuktighet. Dette kan skade de indre delene og ha innflytelse på nøyaktigheten.

Ikke bruk aggressive rensmiddel eller løsemiddel. Skal rengjøres bare med en ren myk klut.

Unngå harde slag på og fall av lasermåleapparatet. Nøyaktigheten av apparatet burde kontrolleres dersom det har falt ned eller har vært utsatt for andre mekaniske belastninger.

Nødvendige reparasjoner på dette laser-apparatet skal kun gjøres av autorisert fagpersonale.

Ikke bruk instrumentet i eksplosjonsfarlige områder eller i aggressive miljøer.

 Elektrisk og elektronisk avfall skal ikke avfallshåndteres sammen med husholdningsavfallet. Brukte batterier, elektrisk og elektronisk avfall skal samles kildesortert og avfallshåndteres.

Fjern brukte batterier, akkumulatører og lysmidler fra apparatene før de kasseres.

Be om informasjon hos de lokale myndighetene eller hos din fagforhandler om miljøstasjoner og samlesteder.

Avhengig av de lokale bestemmelsene kan detaljhandlere være forpliktet til å ta tilbake brukte batterier, elektrisk og elektronisk avfall uten kostnader.

Bidra til å redusere behovet for råmaterialer ved å sørge for gjenbruk og resirkulering av dine brukte batterier og ditt elektriske og elektroniske avfall.

Brukte batterier (særlig litium-ion-batterier), elektrisk og elektronisk avfall inneholder verdifulle, gjenbrukbare materialer som ved ikke-miljøriktig avfallshåndtering kan ha negative konsekvenser for miljøet og din helse.

Slett først eventuelle personrelaterede data fra det brukte apparatet før det avfallshåndteres.

 Europeisk samsvarsmerke

 Britisk samsvarsmerke

 Ukrainsk samsvarsmerke

 Euroasiatisk samsvarsmerke

## TEKNISKE DATA

	LDM 45	LDM 100
Optik	15 mm x 9 mm	18 mm
Måleomåde		
Minimum avstand	0,05 m	0,05 m
Maksimal avstand	45 m (Toleranse: 45,1 m)	100 m (Toleranse: 101 m)
Avstands måling		
Typisk toleranse (gjelder for 100 % måle refleksjon (hvit malt vegg), lav bakgrunnsbelysning, 25 °C)	± 2,0 mm (en ekstra margin på 0,1 mm/m bør det tas hensyn til)	± 2,0 mm (en ekstra margin på 0,1 mm/m bør det tas hensyn til)
Maksimal toleranse (gjelder for mål med mindre refleksjon, høy bakgrunnsbelysning eller temperaturer som nærmer seg den nedre/øvre verdi)	± 4,0 mm (en ekstra margin på 0,15 mm/m bør det tas hensyn til)	± 4,0 mm (en ekstra margin på 0,15 mm/m bør det tas hensyn til)
Minste visbare enhet	1,0 mm	1,0 mm
Laser punkt størrelse		
16 m avstand:	25 x 50 mm	25 x 50 mm
Laser klasse	2	2
Laser type	635 nm, < 1 mW	635 nm, < 1 mW
Laserstråle		
vertikalvinkel	+1 grad	+1 grad
horisontalvinkel	±1 grad	±1 grad
Display type	LCD (31,5 mm x 40 mm)	LCD (31,5 mm x 40 mm)
Automatisk avslåing av laser	90 sekund	90 sekund
Automatisk avslåing av apparatet	180 sekund	180 sekund
Strømforsyning	AAA 2x (Alkaline-batteri)	AAA 2x (Alkaline-batteri)
Batteriets levetid	8000 (Enkeltmåling)	8000 (Enkeltmåling)
Stativgjenger	1/4"	1/4"
Arbeidstemperaturområde	-0°C til +40°C	-0°C til +40°C
Lagertemperaturområdes	-10°C til +60°C	-10°C til +60°C
Vekt uten batteri	87 g	122 g
Verneklasse	IP54 (støv- og sprutevann beskyttet)	IP54 (støv- og sprutevann beskyttet)

## FORMÅLSMESSIG BRUK

Lasermåleapparatet er egnet for måling av avstander og hellinger.  
Dette apparatet må kun brukes til de oppgitte formål.

## FEILKODE TABELL

Kode	Beskrivelse	Løsning
Err500	Hardware problemer	Slå apparatet av og på igjen. Dersom problemet vedvarer så bring måleapparatet til neste servicesenter.

# OVERSIKT

## STATUSLINJE

- ▶ Referanse målepunkt, type måling, målingsvinkel (bare med LDM 100), målingsplan (bare med LDM 100)

## DISPLAY

- ▶ Meny
- ▶ Målinger
- ▶ Innstillinger

## OPPOVER / ADDERE

- ▶ Gå oppover i menyen
- ▶ Addere verdien

## MÅLING / OK

- ▶ Slå på laser
- ▶ Lagre måleverdien
- ▶ Velg OK i menyen

## MENY

- ▶ Historie
- ▶ Måling
- ▶ Innstilling

## NEDOVER / SUBTRAHERE

- ▶ Gå nedover i menyen
- ▶ Subtrahere verdien

## SLETTE / SLÅ PÅ / AV

- ▶ PÅ / AV ( hold tasten trykt til apparatet sender en signaltone)
- ▶ Slette måleverdien

## MÅLINGSPUNKT

- ▶ Bak (Standardinnstilling)
- ▶ Foran
- ▶ Hjørne (blir automatisk aktivert når stiften brettes ut.)



## MÅLING

- ▶ Slå på laser
- ▶ Lagre måleverdien

## SKIFT BATTERI

- ▶ Skift batteri når batterisymbolet blinker

1

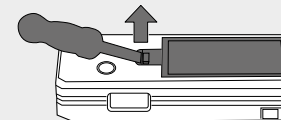

2

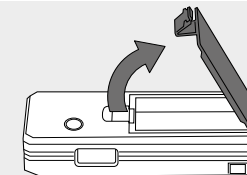

3

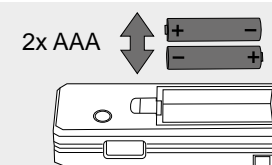

4

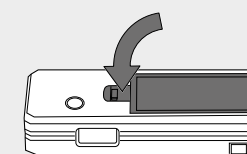

## STATIV

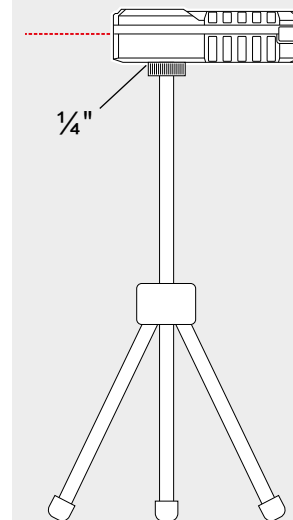

## HJØRNESTIFT

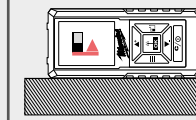
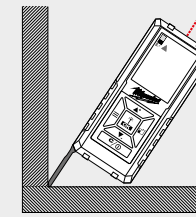

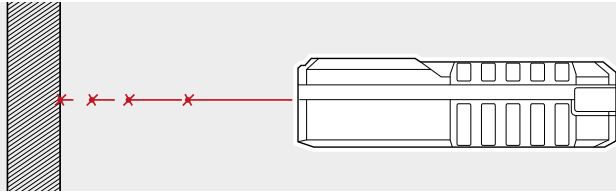

Laserstrålen blinker kontinuerlig under målingen.

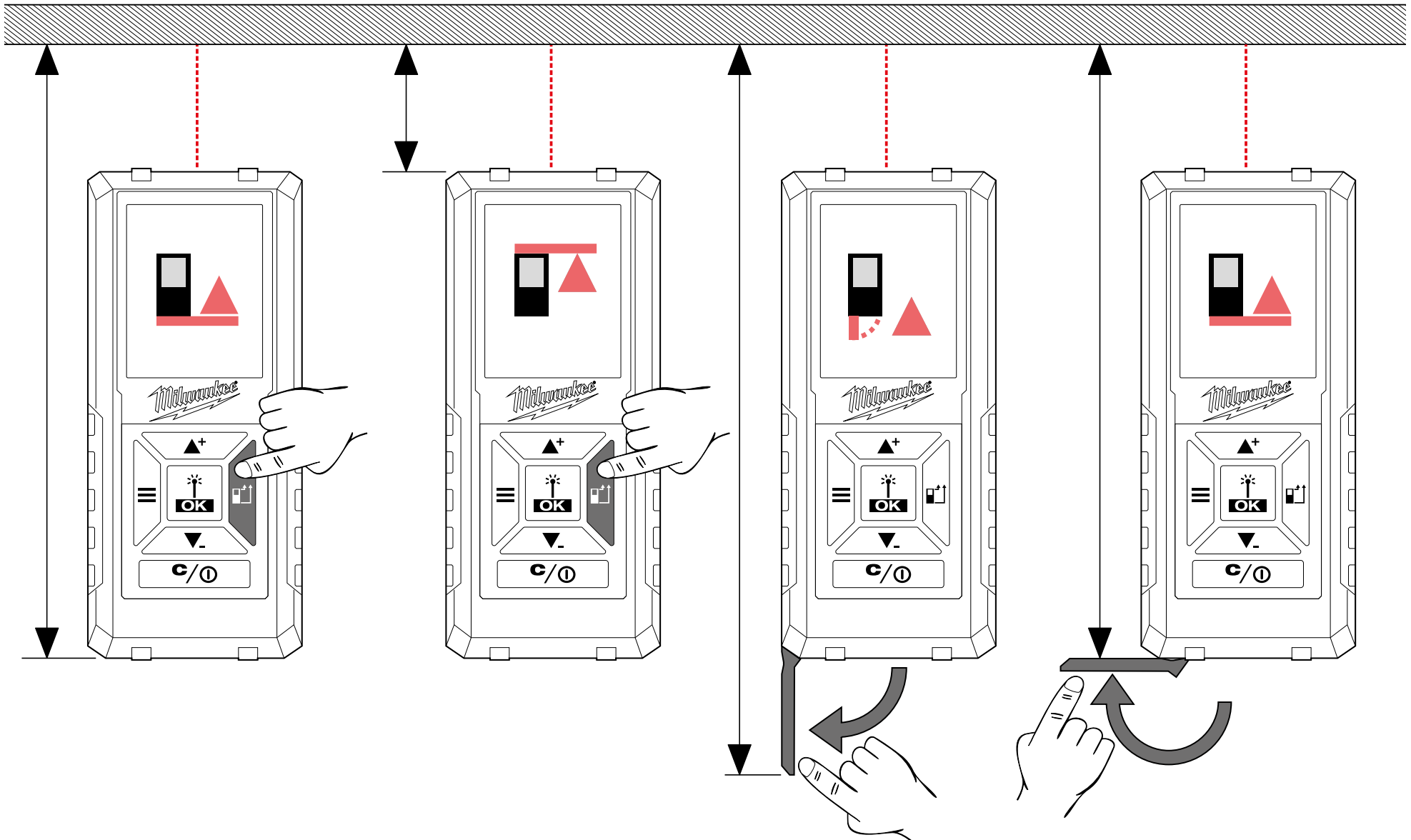

# MENY

## HISTORIE



Vising av de siste 30 målinger/beregninger.  
De individuelle målinger av overflater, hele arealet, volum osv. blir ikke lagret i HISTORIE. Her blir bare resultatet av beregningene lagret.  
For å slette en notering, trykk tast C/PÅ/AV.

Til verdiene i HISTORIE kan målinger/beregninger adderes eller subtraheres. Det kan bare utføres beregninger av samme type målinger (lengde, flate volum osv.)

For å utføre en beregning:

1. Bruk tasten ▲+ ▼- for å velge en målemodus i HISTORIE.
2. Trykk OK-tasten.
3. Gjennomfør målingene som er nødvendig for beregningen.
4. Trykk OK tasten for å lagre den nye beregningen i HISTORIE,

## MÅLING

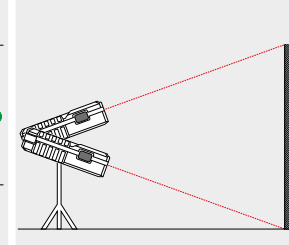
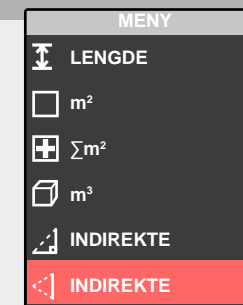
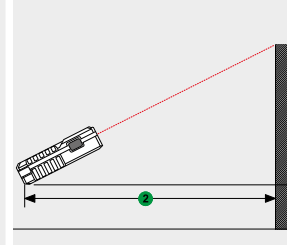
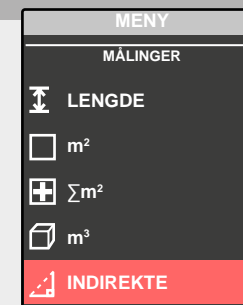
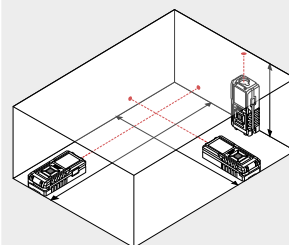
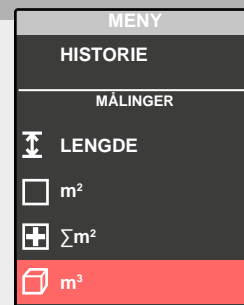
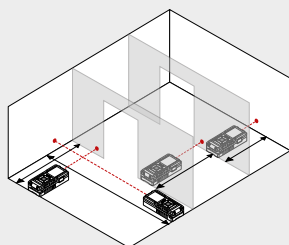
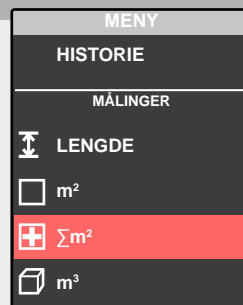
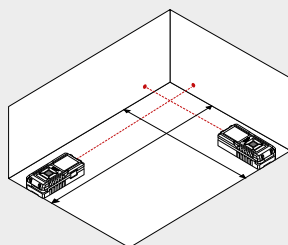
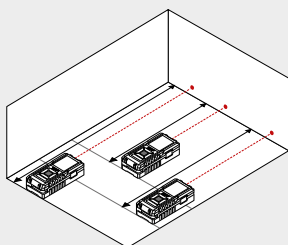
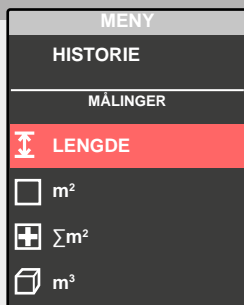

## INNSTILLINGER

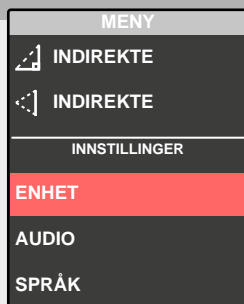

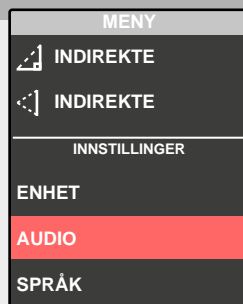

Velg den ønskede måleenheten.

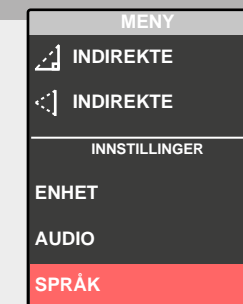

Signaltone på/av.

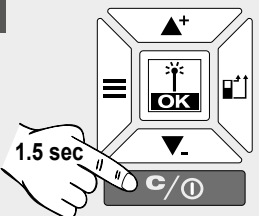
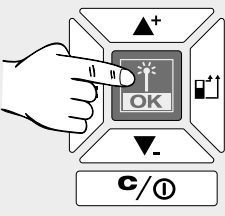
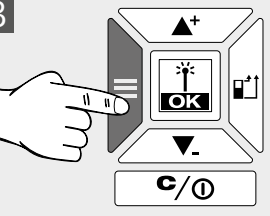
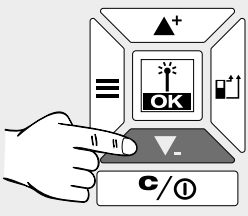
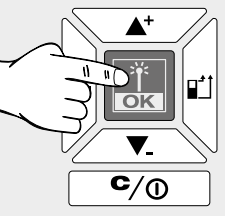

Velg språk.

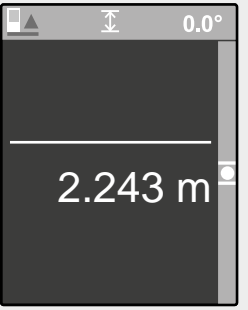
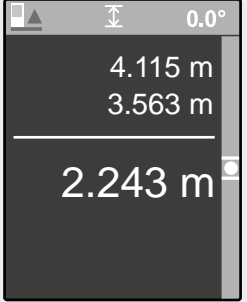
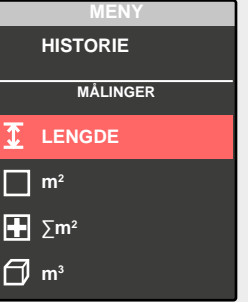
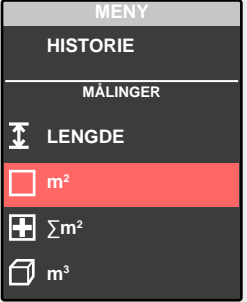
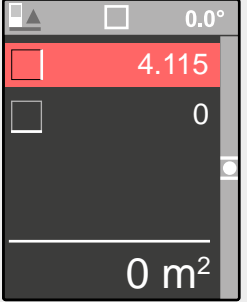
<p>1</p>  <p>1.5 sec</p>	<p>2</p> 	<p>3</p> 	<p>4</p> 	<p>5</p> 
 				
<p>Etter det er slått på, blir automatisk LENGDE MÅLE MODUS aktivert.</p>	<p>Gjennomfør en LENGDEMÅLING eller ...</p>	<p>... Trykk meny-tasten for å skifte meny ...</p>	<p>... Og velg en annen driftstype ved hjelp av tasten ▲+ ▼- og</p>	<p>... Og aktiver denne driftstypen ved å trykke OK-tasten.</p>

# MÅLING AV LENGDE

0



Måleverdi hvit = Verdi er målt

1

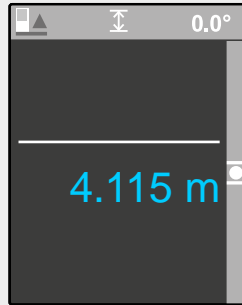
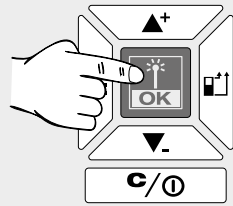

Måleverdi blå = Verdien er mellomlagret

2

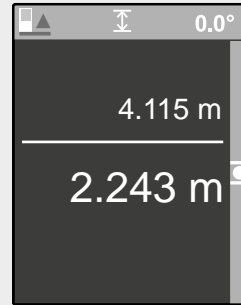
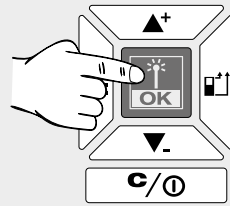

3

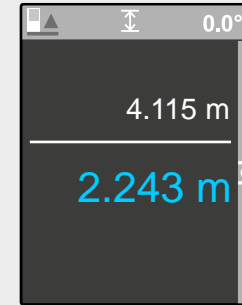
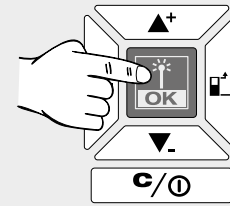

4

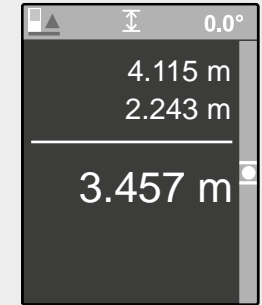
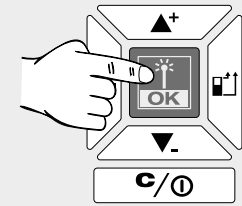

5

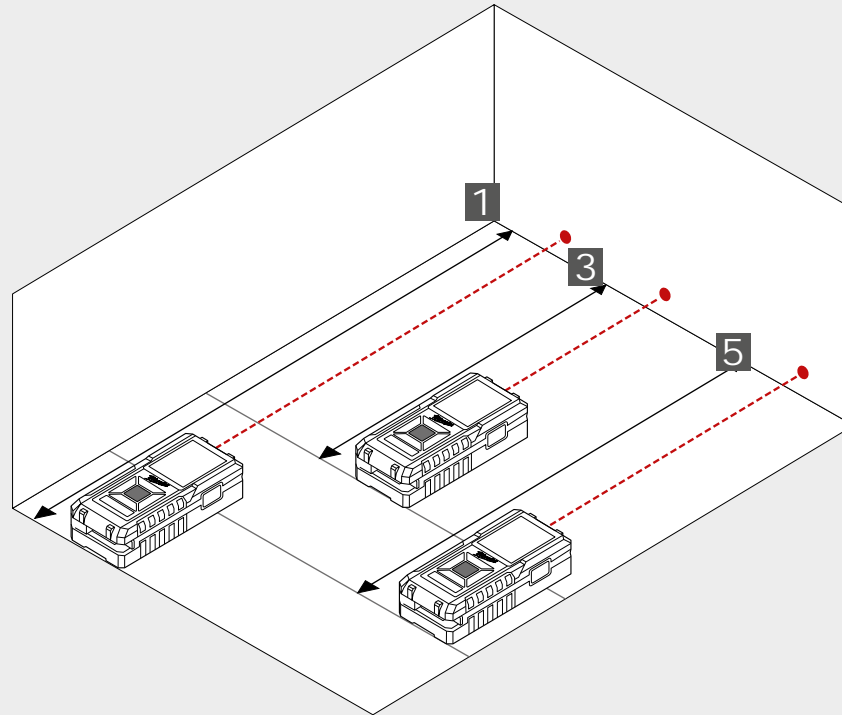
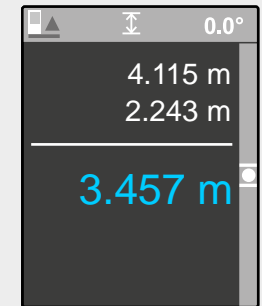
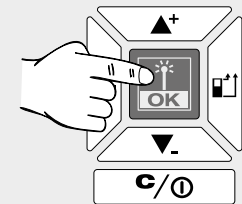



# MÅLING AV FLATE

0

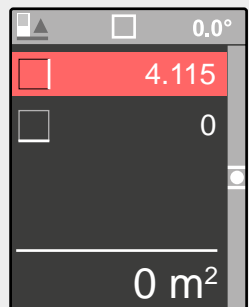

1

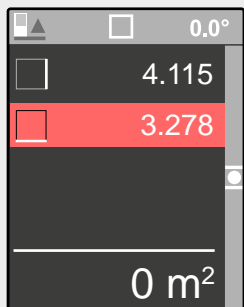
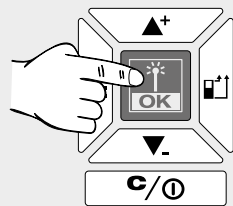

2

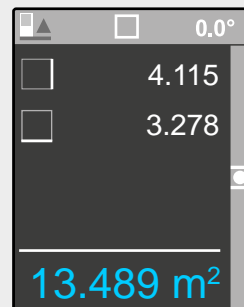
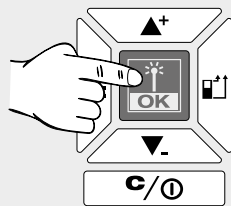

2

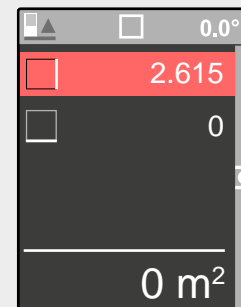
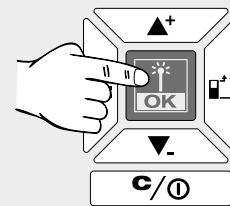

Ny måling.  
Verdien blir lagret i HISTORIE

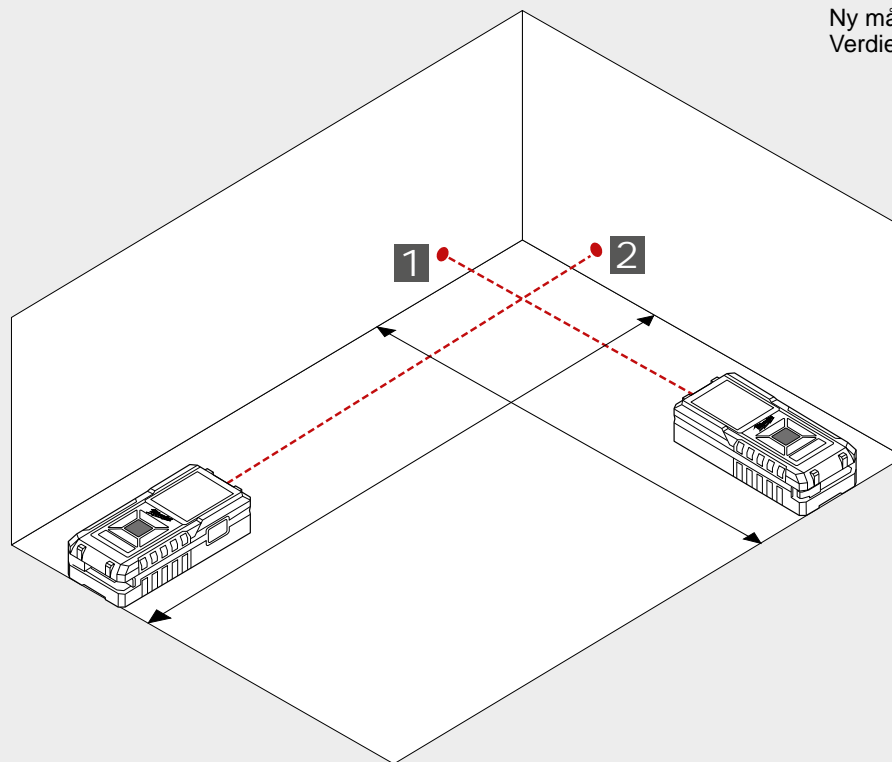

# MÅLING AV HELE AREAET

0

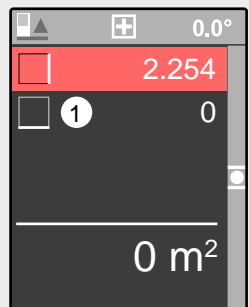

1

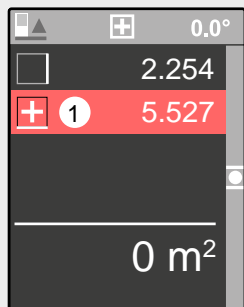
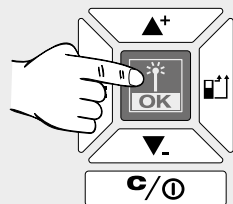

2

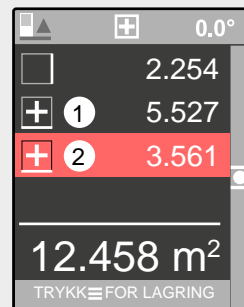
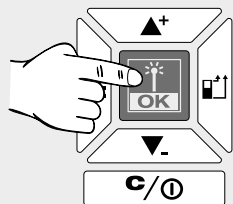

3

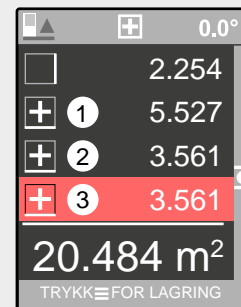
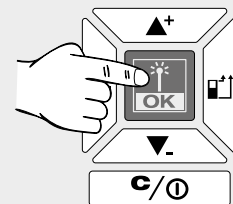

4

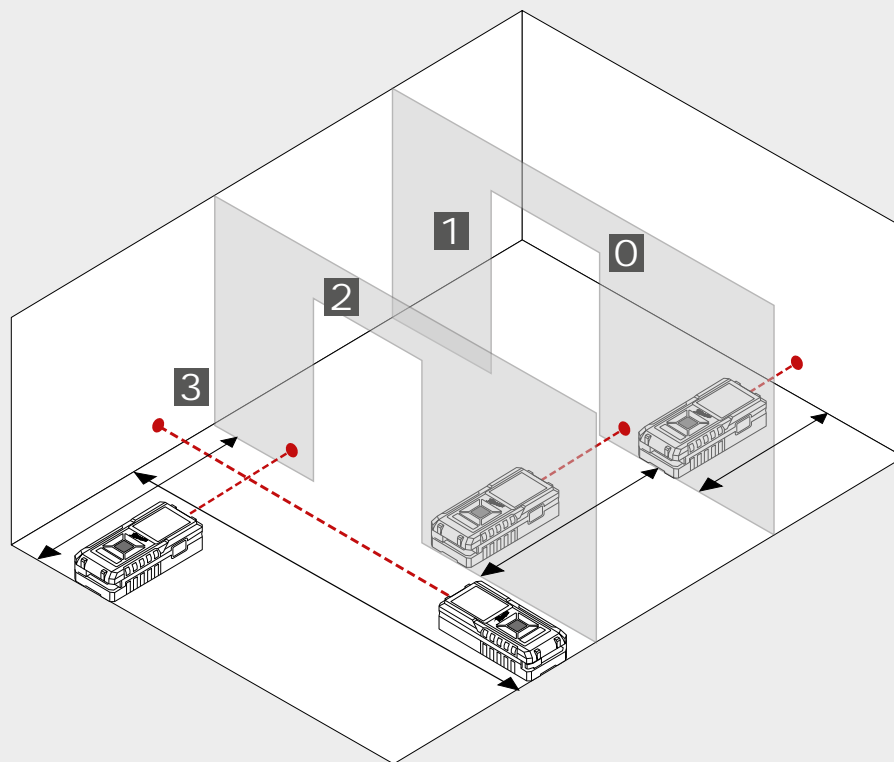
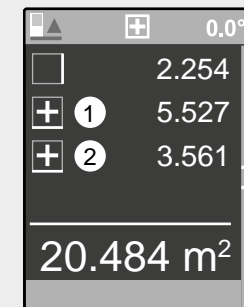
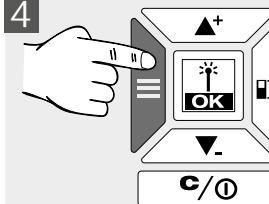

4

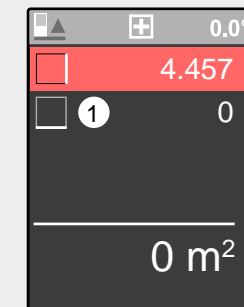
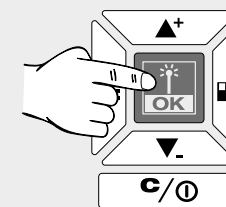

Ny måling.  
Resultat blir lagret i HISTORIE

# MÅLING AV VOLUM

0

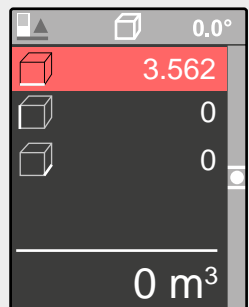

1

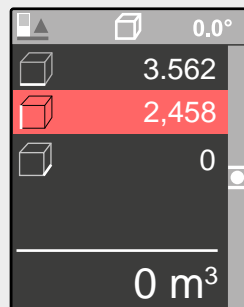
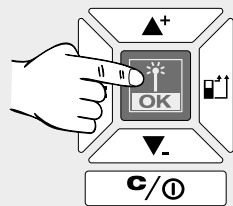

2

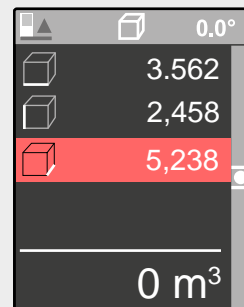
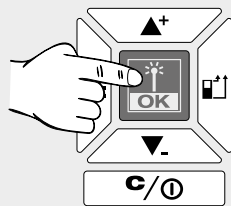

3

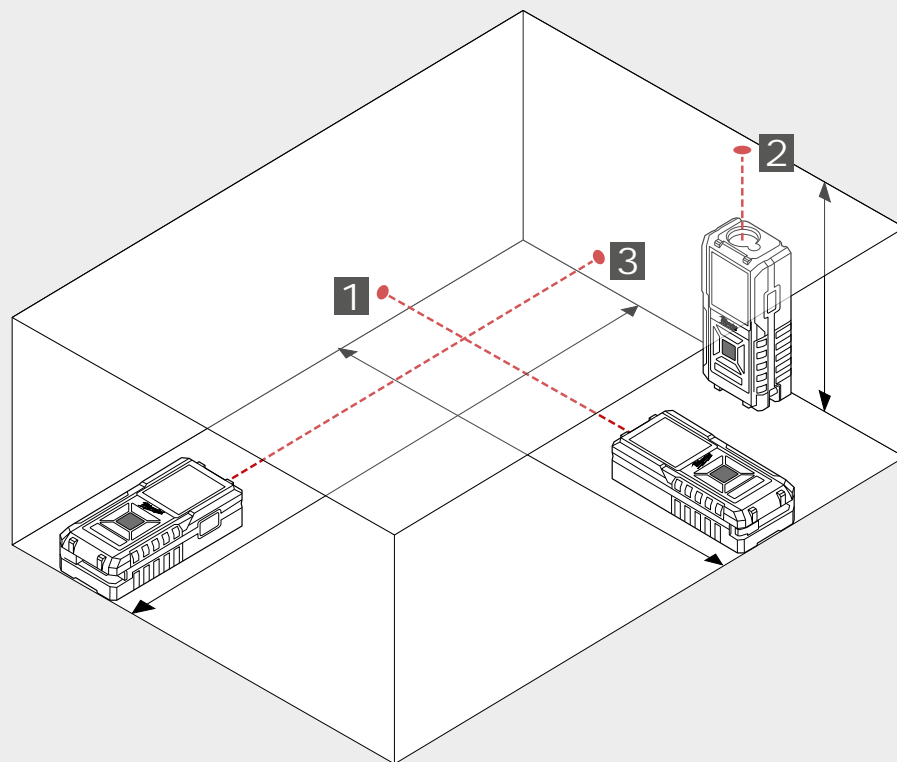
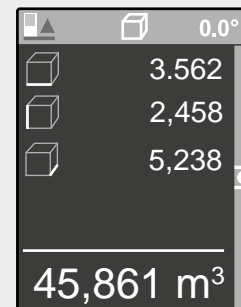
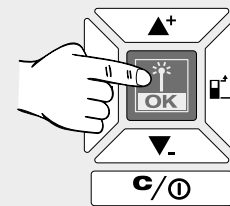

# INDIREKTE HØYDE-/LENGDEMÅLING (BARE MED LDM 100)

0

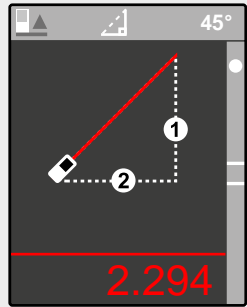

1

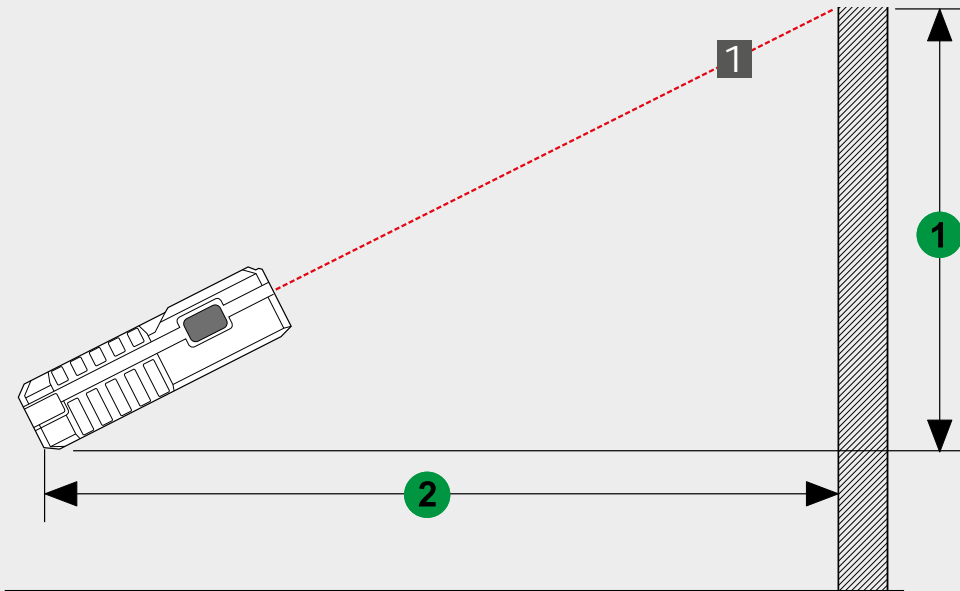
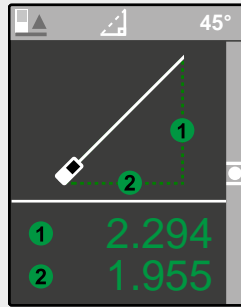
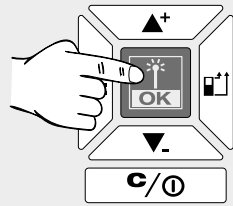

# INDIREKTE HØYDEMÅLING (BARE MED LDM 100)

0

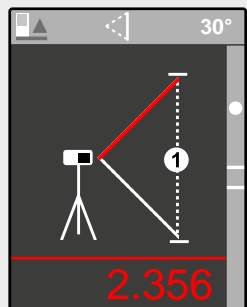

1

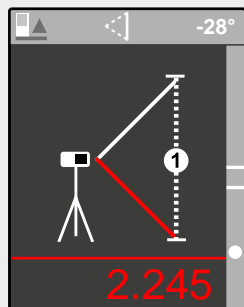
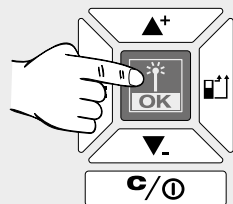

2

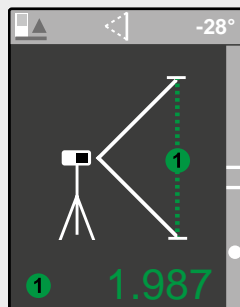
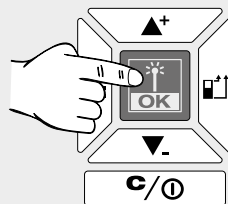

Bruk et stativ eller en annen stabil overflate for å måle to forskjellige lengder.

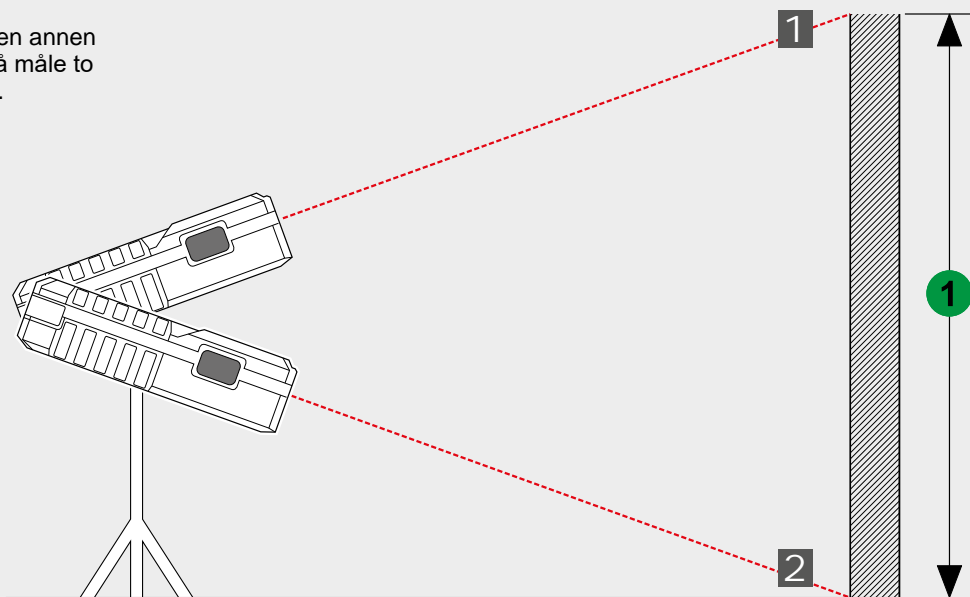

## INNEHÅLL

Viktiga säkerhetsföreskrifter .....	1
Tekniska data.....	2
Använd maskinen enligt anvisningarna.....	2
Tabell med felkoder .....	2
Översikt .....	3
Mätpunkt.....	4
Meny.....	5
Starta .....	6
Längdmätning.....	7
Ytmätning .....	8
Mäta totalyta.....	9
Volymmätning.....	10
Indirekt höjd-/längdmätning (endast med LDM 100) .....	11
Indirekt höjdmätning (endast med LDM 100) .....	12

## VIKTIGA SÄKERHETSFÖRESKRIFTER



Använd inte denna produkt utan att läsa säkerhetsföreskrifter och handbok på bifogad CD.

### Laserklassificering

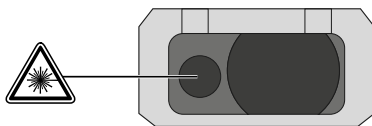

### VARNING:

Produkten motsvarar klass 2 enligt: EN60825-1:2014



LASERAPPARAT FÖR KONSUMENTER  
EN 50689:2021

### Varning:

Undvik direkt blickkontakt: Laserstrålen kan blixtra i ögonen och leda till en kortvarig bländning.

Titta inte in i laserstrålen och rikta den inte mot andra personer i onödan.

Blända inte andra personer.

### Varning:

Använd laser-apparaten aldrig i närheten av barn och tillåt barn aldrig att använda laser-apparaten .

Varning! En reflekterande yta kan kasta tillbaka laserstrålen till användaren eller andra personer.

Håll fingrarna på säkert avstånd från roterande komponenter.

Utför periodiska kontrollmätningar. Särskilt före, under och efter viktiga mätningar.

Se upp för felaktiga mätningar om en defekt produkt används, efter ett fall eller andra otillåtna påfrestningar resp. förändringar av produkten.

**Varning:** Användning av manöverkomponenter och inställningar eller andra förfaranden resp. metoder som inte nämns i manualen kan orsaka farlig strålbelastning.

Lasermätinstrumentet har ett begränsat användningsområde. (Se avsnittet Tekniska data). Försök att göra mätningar utanför det maximala resp. det minimala området leder till bristande noggrannhet. Användning vid ogynnsamma förhållande som för kallt, för varmt, starkt solljus, regn, snö, dimma eller andra förhållanden som begränsar sikten kan leda till oprecisa mätningar.

Om lasermätinstrumentet förs från en varm omgivning till en kall omgivning (eller tvärt om), vänta tills instrumentet har anpassat sig till den nya omgivningstemperaturen.

Förvara alltid lasermätinstrumentet i utrymmen som skyddar instrumentet mot skakningar, vibrationer eller extrema temperaturer.

Skydda lasermätinstrumentet mot damm, fukt och hög luftfuktighet. Detta kan förstöra komponenter inne i instrumentet påverka noggrannheten.

Använd inga aggressiva rengöringsmedel eller lösningsmedel. Rengör endast med en ren, fuktig trasa.

Undvik kraftiga slag mot instrumentet och låt det inte falla till marken. Instrumentets noggrannhet bör kontrolleras om det har fallit till marken eller har utsatts för andra mekaniska belastningar.

Om denna laser-apparat behöver repareras så får endast auktoriserad fackpersonal utföra reparationen.

Använd inte produkten i aggressiv eller explosiv miljö.

 Förbrukade batterier och avfall som utgörs av eller innehåller elektrisk och elektronisk utrustning (WEEE) får inte slängas tillsammans med de vanliga hushållssoporna. Förbrukade batterier eller WEEE ska samlas och avfallshanteras separat.

Ta ut förbrukade batterier, förbrukade ackumulatörer och ljuskällor ur produkterna innan de avfallshanteras. Kontakta den lokala myndigheten respektive kommunen eller fråga återförsäljare var det finns speciella avfallsstationer för elskrot.

Beroende på de lokala bestämmelserna kan återförsäljare vara skyldiga att ta tillbaka förbrukade batterier eller WEEE gratis. Bidra till att minska behovet av råämnen genom återanvändning och återvinning av dina förbrukade batterier eller ditt WEEE.

Förbrukade batterier (i synnerhet litiumjonbatterier) och WEEE innehåller värdefulla återvinningsbara material som kan skada miljön och din hälsa om de inte avfallshanteras på korrekt sätt. Tänk på att radera eventuella personuppgifter som kan finnas på din utrustning innan du lämnar den till avfallshanteringen.

 Europeisk symbol för överensstämmelse

 Brittisk symbol för överensstämmelse

 Ukrainskt konformitetsmärke

 Euroasiatiskt konformitetsmärke

## TEKNISKA DATA

	LDM 45	LDM 100
Optik	15 mm x 9 mm	18 mm
Mätområde		
Minimalt avstånd	0,05 m	0,05 m
Maximalt avstånd	45 m (Tolerans: 45,1 m)	100 m (Tolerans: 101 m)
Avståndsmätning		
Typisk tolerans (gäller för 100 % målreflektion (vit lackerad vägg), låg bakgrundsbelysning, 25 °C)	± 2,0 mm (en ytterligare tolerans på 0,1 mm/m bör beaktas)	± 2,0 mm (en ytterligare tolerans på 0,1 mm/m bör beaktas)
Maximal tolerans (gäller för mål med lägre reflektion, hög bakgrundsbelysning eller temperaturer som närmar sig det nedre/övre värdet)	± 4,0 mm (en ytterligare tolerans på 0,15 mm/m bör beaktas)	± 4,0 mm (en ytterligare tolerans på 0,15 mm/m bör beaktas)
Minsta enhet som kan visas	1,0 mm	1,0 mm
Laserpunktstorlek		
16 m avstånd:	25 x 50 mm	25 x 50 mm
Laserklass	2	2
Lasertyp	635 nm, < 1 mW	635 nm, < 1 mW
Laserstråle		
vertikalvinkel	+1 grad	+1 grad
horisontalvinkel	±1 grad	±1 grad
Displaytyp	LCD (31,5 mm x 40 mm)	LCD (31,5 mm x 40 mm)
Automatisk laseravstängning	90 sekunder	90 sekunder
Automatisk apparatavstängning	180 sekunder	180 sekunder
Strömförsörjning	AAA 2x (alkali-batteri)	AAA 2x (alkali-batteri)
Batteriets livstid	8000 (enskild mätning)	8000 (enskild mätning)
Stativgänga	1/4"	1/4"
Arbetstemperaturområde	-0°C till +40°C	-0°C till +40°C
Lagertemperaturområde	-10°C till +60°C	-10°C till +60°C
Vikt utan batteri	87 g	122 g
Skyddsklass	IP54 (damm- och stänkvattenskydd)	IP54 (damm- och stänkvattenskydd)

## ANVÄND MASKINEN ENLIGT ANVISNINGARNA

Lasermätinstrumentet är avsett att användas för mätning av avstånd och lutningar.

Maskinen får endast användas för angiven tillämpning.

## TABELL MED FELKODER

Kod	Beskrivning	Lösning
Err500	Hårdvaruproblem	Stäng av mätinstrumentet och slå på det igen. Om problemet kvarstår, ta mätinstrumentet till närmaste service center.

# ÖVERSIKT

## STATUSRAD

- ▶ Referensmät punkt, typ av mätning, mätvinkel (endast med LDM 100), mätnivåer (endast med LDM 100)

## DISPLAY

- ▶ Meny
- ▶ Mätningar
- ▶ Inställningar

## UPP/ADDERA

- ▶ Gå uppåt i menyn
- ▶ Addera värde

## MÄTNING/OK

- ▶ Starta laser
- ▶ Spara mätvärde
- ▶ Välja OK i menyn

## MENY

- ▶ Historik
- ▶ Mätning
- ▶ Inställningar

## NEDÅT/SUBTRAHERA

- ▶ Gå nedåt i menyn
- ▶ Subtrahera värde

## RADERA/STÄNGA AV/SLÅ PÅ APPARATEN

- ▶ PÅ/AV (håll knappen intryckt tills apparaten avger en signalton)
- ▶ Radera mätvärde

## MÄTPUNKT

- ▶ Baktill (standardinställning)
- ▶ Framtill
- ▶ Hörn (aktiveras automatiskt genom att stiftet fälls ut)

## MÄTA

- ▶ Starta laser
- ▶ Spara mätvärde

## BYTA BATTERIER

- ▶ Byt batterier när batterisymbolen blinkar.

1

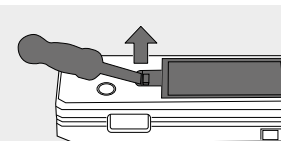

2

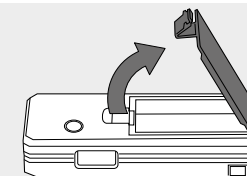

3

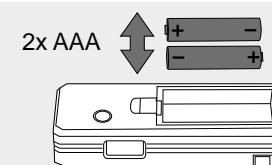

4

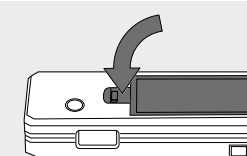

## STATIV

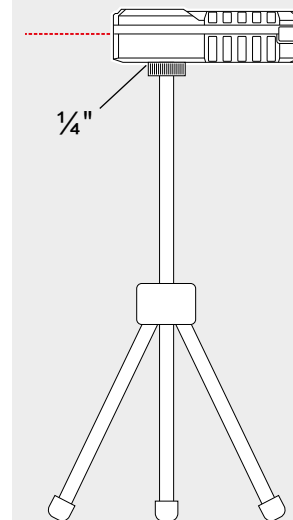

## HÖRNSTIFT

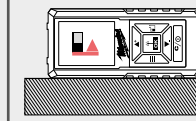
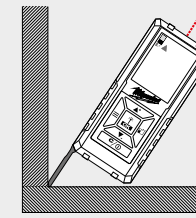



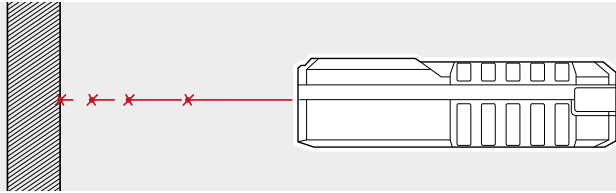

Laserstrålen blinkar oavbrutet under mätningen.

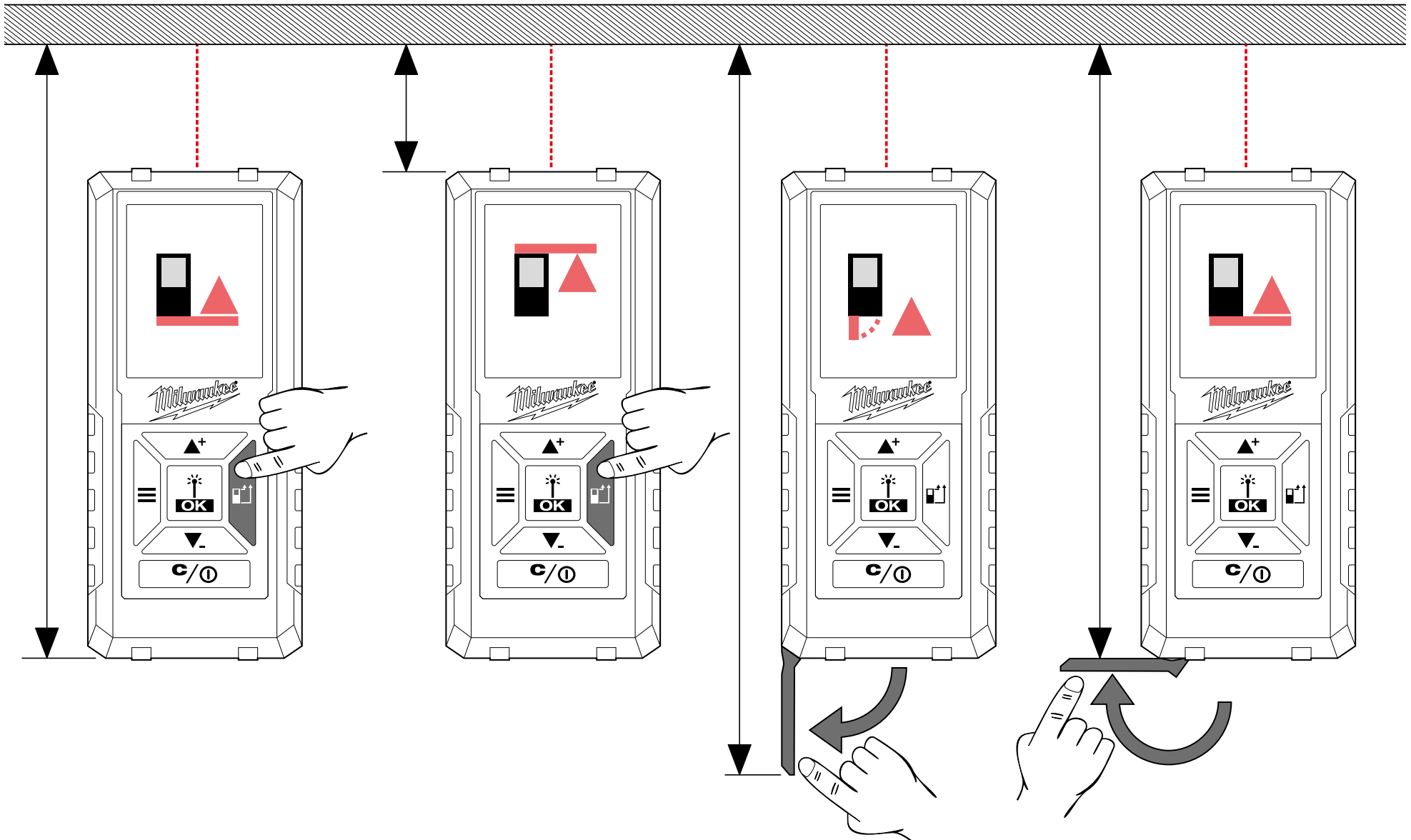

# MENY

## HISTORIK



Visning av de senaste 30 mätningarna/beräkningarna.

De enskilda mätningarna för beräkning av yta, totalyta, volym m.m. sparas inte under HISTORIK utan bara resultatet av beräkningarna.

För att radera en post, tryck på knappen C/PÅ/AV.

Mätningar/beräkningar kan adderas till eller subtraheras från de värden som är sparade under HISTORIK. Endast beräkningar av samma typ (längd, yta, volym m.m.) kan utföras.

Utföra en beräkning:

1. Använd knapparna ▲+ ▼- för att välja en mätning från HISTORIK.
2. Tryck på OK knappen.
3. Utför de mätningar som krävs för beräkningen.
4. Tryck på knappen OK för att spara den nya beräkningen i HISTORIK.

## MÄTNING

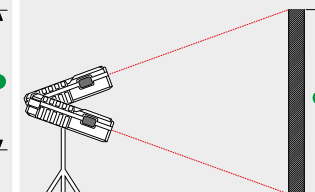
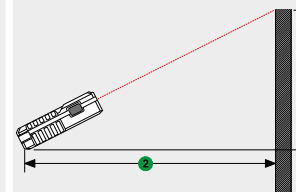
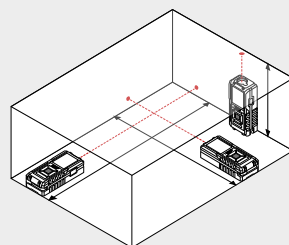
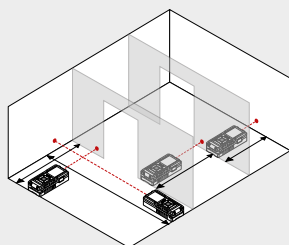
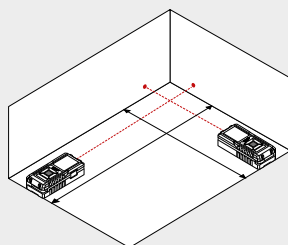
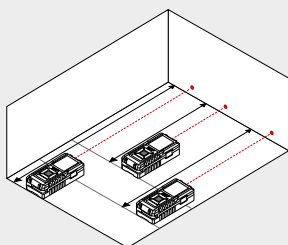
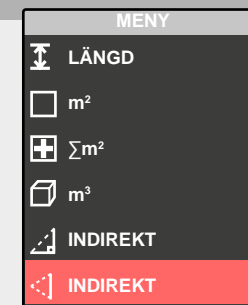
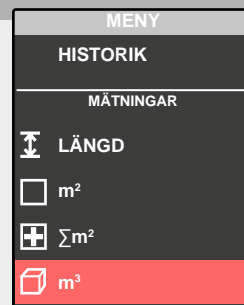
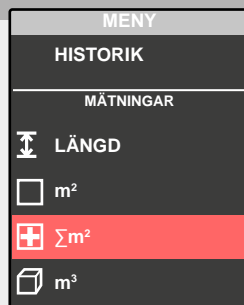
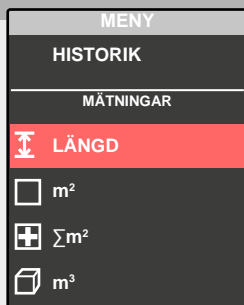

## INSTÄLLNINGAR





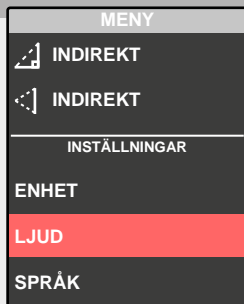

Välj önskad mätenhet.

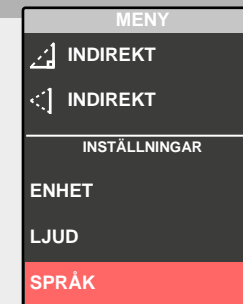

Signalton på/av.

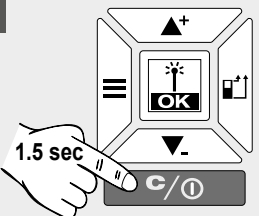
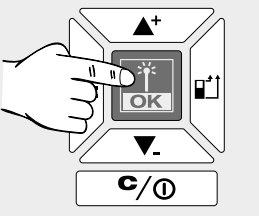
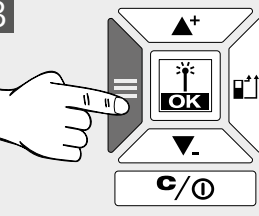
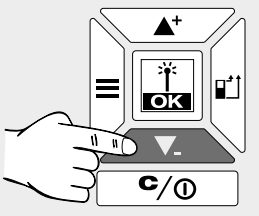
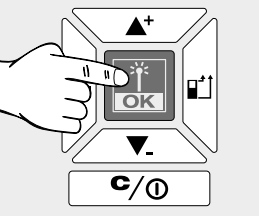

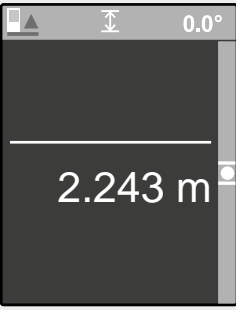
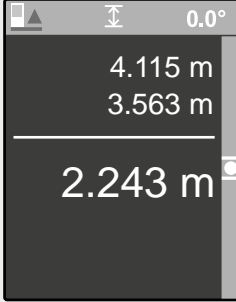
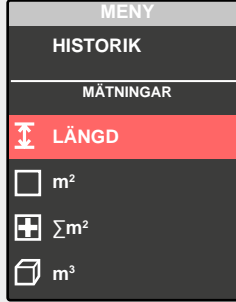
Välja språk.

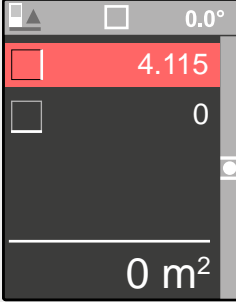
<p>1</p> 	<p>2</p> 	<p>3</p> 	<p>4</p> 	<p>5</p> 
 				
<p>Efter påslagning aktiveras automatiskt LÄNGDMÄTNING.</p>	<p>Utför en LÄNGDMÄTNING eller ...</p>	<p>... tryck på menyknappen för att gå till menyn ...</p>	<p>... och välj ett annat läge med hjälp av knapparna ▲+ ▼- och ...</p>	<p>... och aktivera detta läge genom att trycka på knappen OK.</p>

0



Mätvärde vitt = värdet har mätts

1

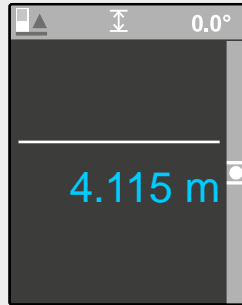
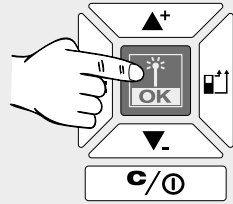

Mätvärde blått = värdet har frysts

2

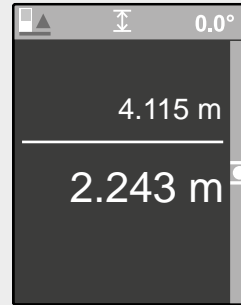
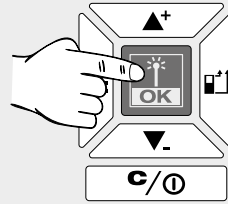

3

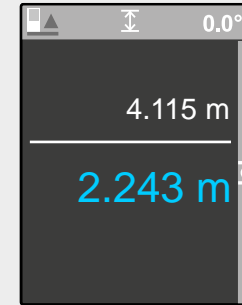
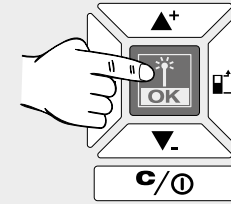

4

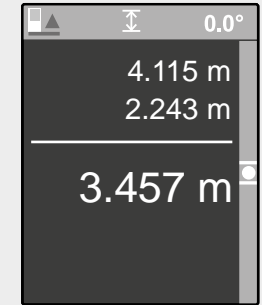
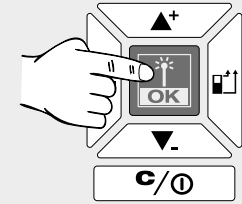

5

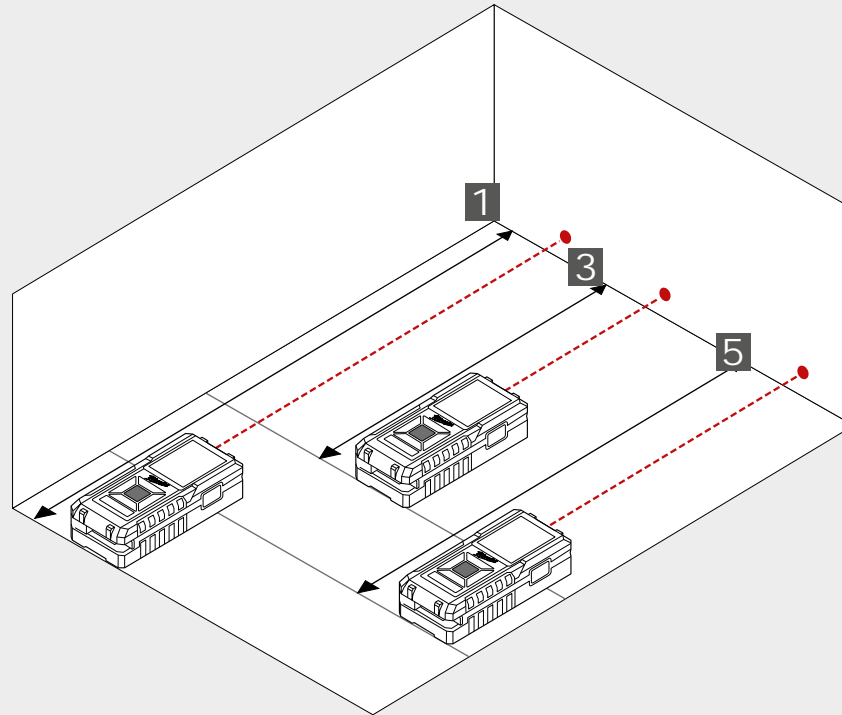
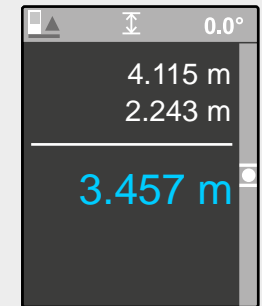
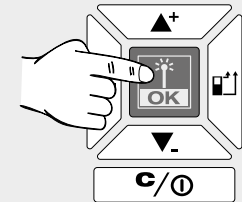

0

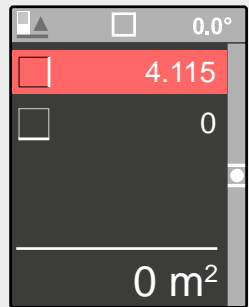

1

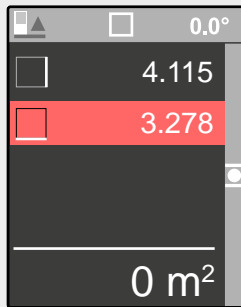
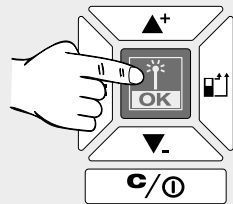

2

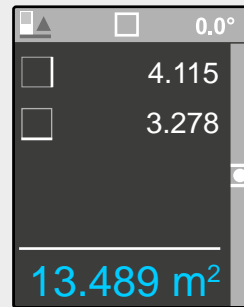
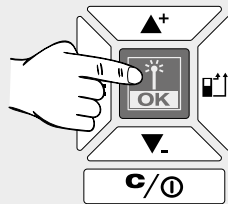

2

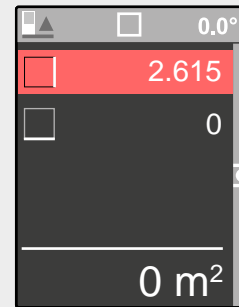
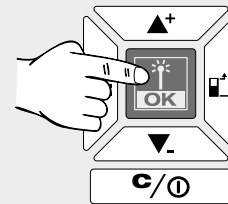

Ny mätning.  
Värdet sparas under HISTORIK.

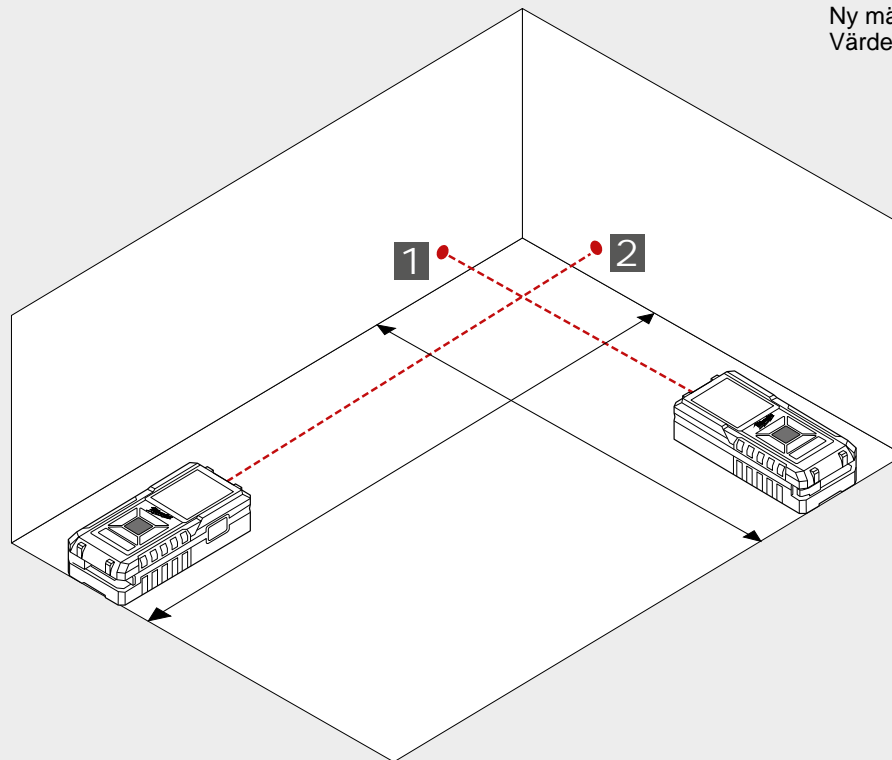

0

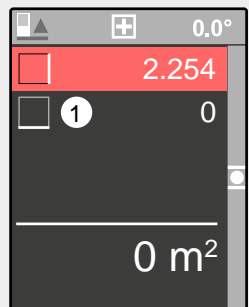

1

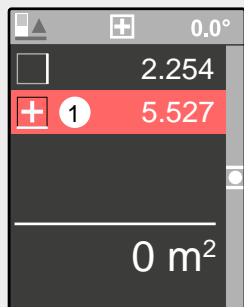
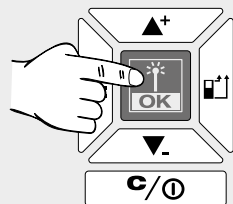

2

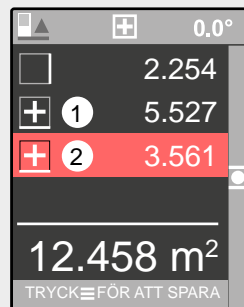
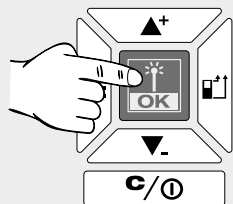

3

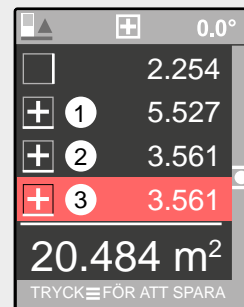
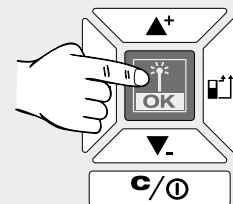

4

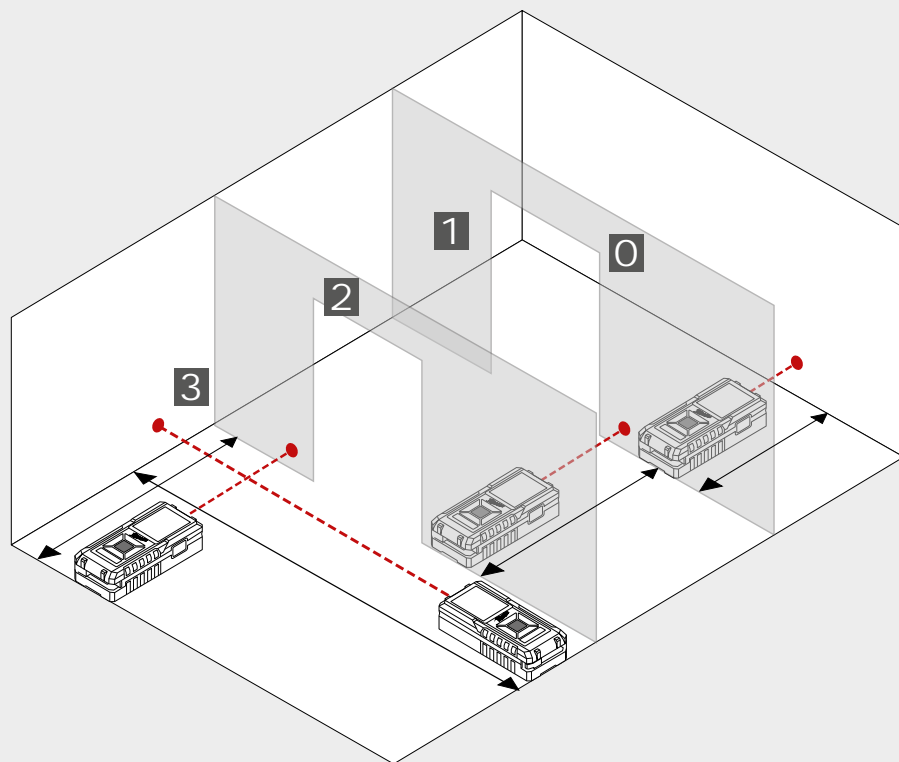
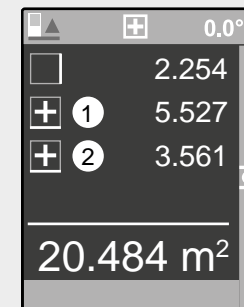
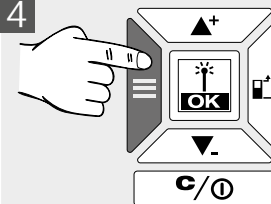

4

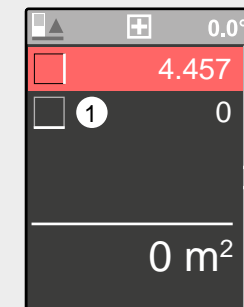
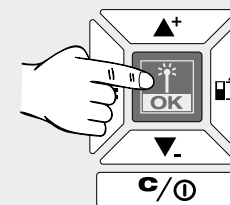

Ny mätning.  
Resultatet sparas under HISTORIK.

0

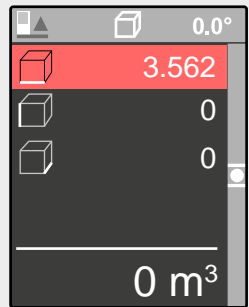

1

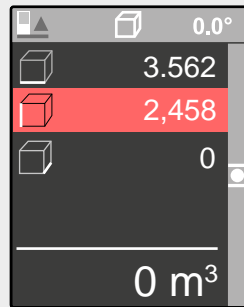
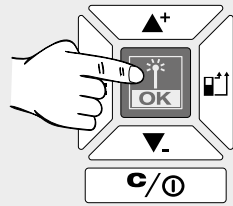

2

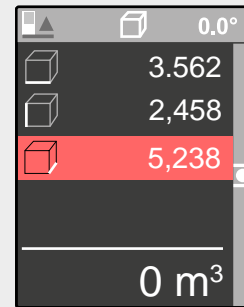
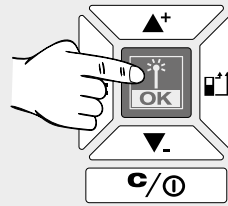

3

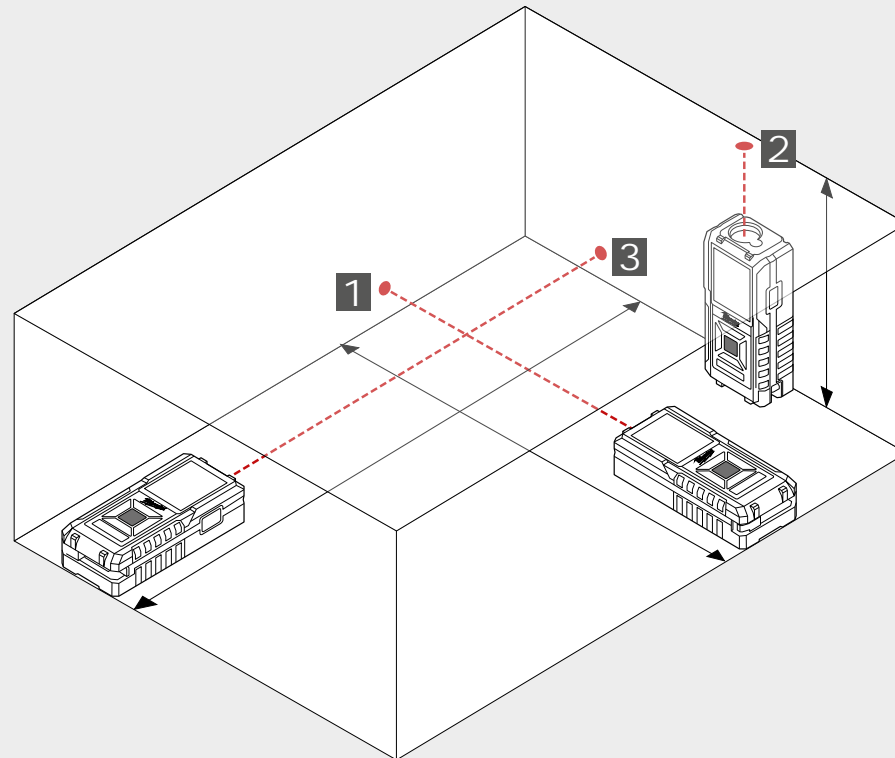
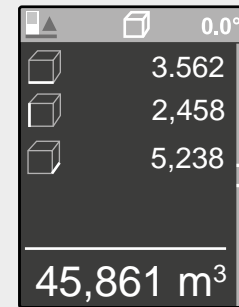
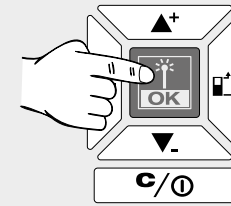

0

1

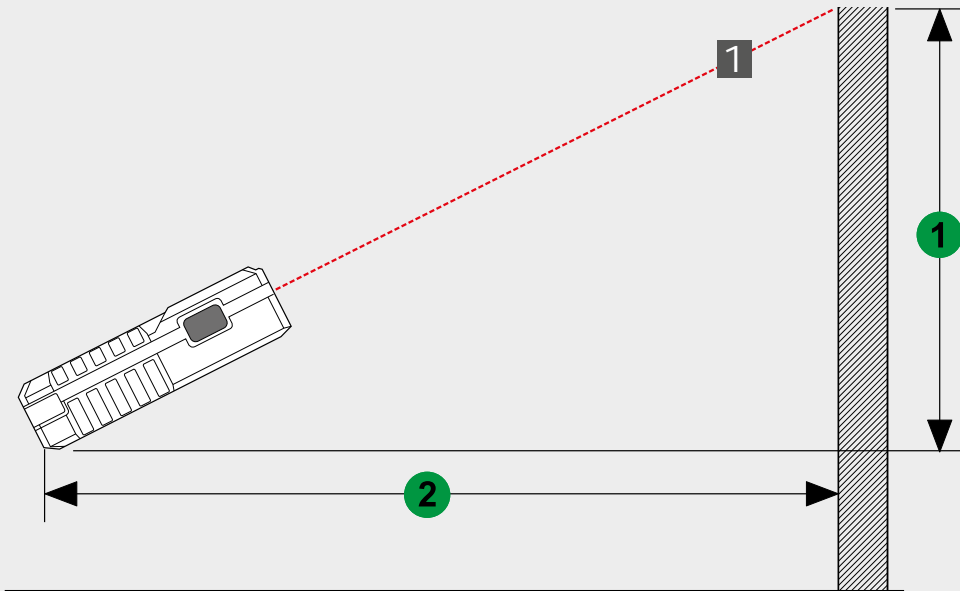
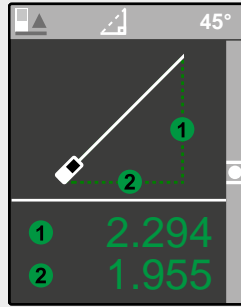
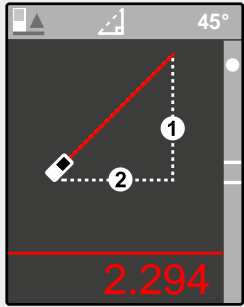
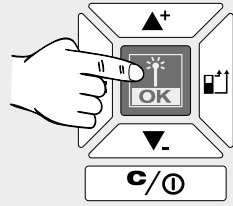



# INDIREKT HÖJDMÄTNING (ENDAST MED LDM 100)

0

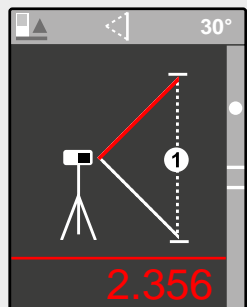

1

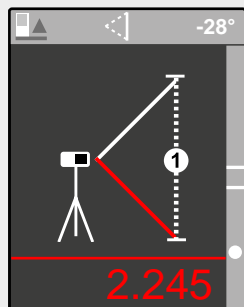
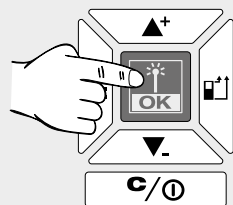

2

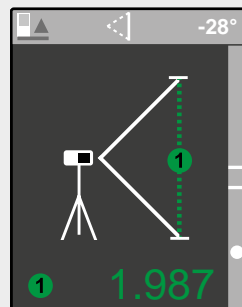
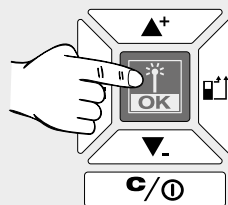

Använd ett stativ eller en annan stabil yta för att mäta två olika längder.

